



AH & MET[®]

yüzlerce ürün
tek güvence...

20.years

1998 yılında kurulan firmamız paket asansör ve ekipmanları satışı yapan, Türkiye'nin önde gelen lider firmalarındandır. Yurt içinde doğu'dan batıya , kuzeyden güney'e geniş bir hizmet yelpazesi oluşturan firmamız , müşterilerinden aldığı güvenle son yıllarda 48 ülkeye ihracat yaparak bu yelpazesini yurtdışında da genişletmiştir.

Türkiye'nin sanayi merkezi Konya'da 20.000 m² fabrikamızda , kabin, kontrol sistemleri, yarı ve tam otomatik kapı , süspansiyon ve şase üretmekteyiz. Ürünlerimizi Avrupa Standartları (CE) , Rusya Standartları (EAC) ve Ukrayna Standartlarına göre üretmekte ve belgelendirmekteyiz. Firmamız yüksek kalite ve zamanında teslimat prensibi ile çalışarak birçok yerli ve yabancı markanın satışını yapmaktadır. Ülkemizde ve dünyadaki gelişmeleri sürekli takip eden genç ve dinamik kadromuz ile teknolojik gelişimi ve yeniliği hedefleyen firmamız, müşteri odaklı hizmet anlayışı ile geçmişin ışığı altında geleceğe sağlam adımlar atarak sektörde yerini almaya devam edecektir.

Founded in 1998, our company package lifts and equipment is one of Turkey's leading company in sales. By creating a wide service range from East to West and North to South in domestic market our company has extended the range to 48 countries to Thanks to customers trust in recent years.

We produce cabin , control systems , doors , suspension and chassis according to special shaft in 20.000 m² place factory in Industry center of Turkey is Konya . All products have certificate European Standard (CE) , Russian Standard (EAC) and Ukranian Certificate. Our company is working with high quality and timely delivery principle at the same time too many Domestic and foreign brand products selling. Continuously tracking progress in our country and in the world our company with its young and dynamic staff targeted at technological development and innovations , customers oriented service conception makes firm steps to the future in the light of the past and will continue to be involved in the sector side by side with its clients.

Наша компания была основана 1998 году и занимается производством лифтового оборудования, а так же компонентов к данному оборудованию. Являясь одним из лидеров по производству и продаже в этой отрасли; мы предоставляем качественные услуги как внутри Турецкой Республики, так и более 100 зарубежным фирмам из 48 страны. Завод находится в городе Конья Турецкой Республики и имеет 20 000 квадратных метров. Производство оснащено последним технологическим парком оборудования и производит такие компоненты как: двери, кабины, станции управления и специальные рамы для шахты. Вся продукция производится строго по европейскому (CE) и евразийскому (EAC) стандарту и владеет сертификатами различных стран. Также Вы можете приобрести у нас качественную продукцию известных Европейских и Турецких марок по приемлемым ценам и своевременной доставкой. Мы динамично развивающаяся фирма с профессиональными квалифицированными кадрами постоянно инновационно-модернизируя свою продукцию уверенно шагаем в перед. Качество, надежность и безопасность продукции - это основной приоритет политики нашей компании.

منذ عام 1998 تعد شركتنا إحدى الشركات التركية الرائدة في مجال بيع المصاعد الكاملة وكامل مستلزماتها . من خلال إنشاء شبكة خدمات واسعة من الشمال إلى الجنوب ومن الشرق إلى الغرب في السوق المحلية ، استطاعت شركتنا أن توسع نطاق خدماتها لتشمل 48 دولة في السنوات الأخيرة ، لتكسب بذلك ثناء وثقة العملاء .

نحن ننتج الكابائن ولوحات التحكم والأبواب الأتوماتيكية والنصف أوتوماتيكية والتعليق والشاسيهات ، في مساحة 20.000 متر مربع من مدينة قونيا التي تعد أكبر مركز صناعي في تركيا .

جميع منتجاتنا حائزة على شهادات المواصفات القياسية الأوروبية (CE) والروسية (EAC) والأوكرانية . تعمل شركتنا بمبدأ التصنيع بأعلى مستويات الجودة والتسليم بالوقت المناسب المحدد ، وفي السياق ذاته نبيع منتجات العديد من الماركات المحلية والأجنبية . تلاحق شركتنا ركب التطور والتقدم في بلدنا وفي العالم بموظفيها الشباب وفنييها ومهندسيها ، وتهدف إلى التطوير المستمر والابتكار ، وتخطط خطوات وثقة نحو المستقبل على ضوء تجارب الماضي ، وتواصل تقديم خدماتها المتكاملة في هذا القطاع جنباً إلى جنب عملائها.



SERTİFİKALAR CERTIFICATES

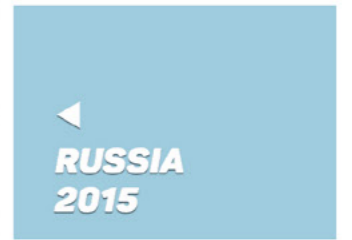
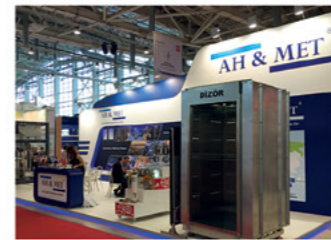
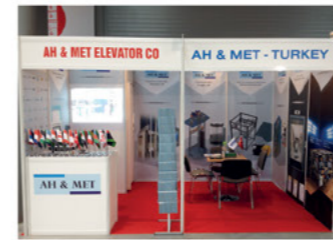
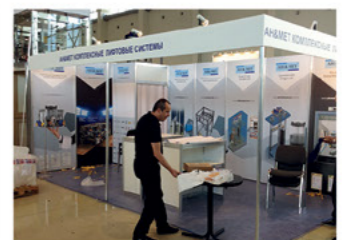
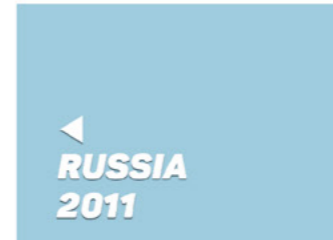
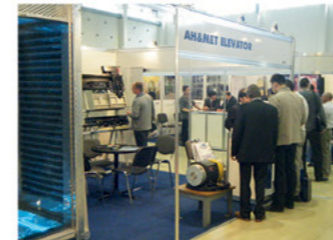
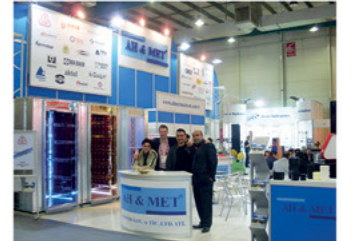
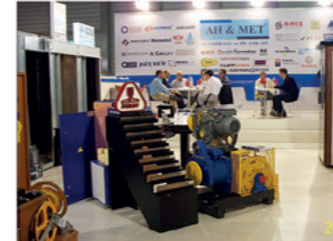
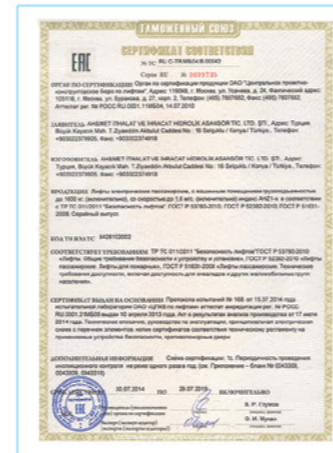
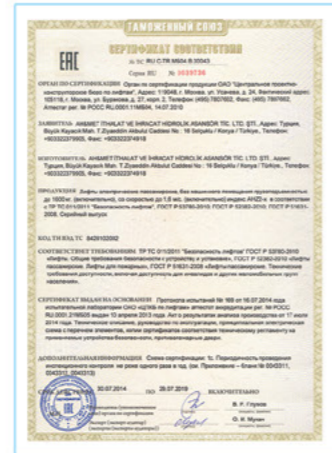

KABINLER CABINS

ÖZELLİKLER

- Duvarlar 1,5 mm galvanizli sac
- Laminant kabinler 18 mm radüslü
- Paslanmaz kabinler 304 kalite
- Komple lazer tavan
- Cam kabinlerde farklı renk ve desen uygulamaları
- Cam ve led tavan seçeneği
- PVC anti bakteriyel taban
- 20 mm doğal granit taban seçeneği
- Farklı taban seçenekleri
- Çalıştırılmaya hazır aydınlatma ve fan
- Titreşimi önleyen özel bükümler ve takozlar
- Tercihe bağlı sandık ambalaj

المواصفات

- الجدار 1.5 مم من الألواح الحديدية.
- الكيائن الخشبية الخشب بسماكة 18 مم .
- الكيائن الستانلس ستيل بجودة 304 .
- السفقيات قص ليزر .
- تنفيذ زجاج الكبينة بمختلف الألوان والتصاميم .
- خيارات متعددة للزجاج وإضاءة الأسقف .
- الأرضية PVC مضادة للبكتيريا .
- خيارات الأرضية من الغرانيت الطبيعي بسماكة 20 مم .
- خيارات متنوعة من الأرضيات .
- الإضاءة والمروحة بمهزة للتشغيل .
- قواعد التثبيت خاصة لمنع الاهتزاز .
- التشغيل حسب الرغبة .
- المكايح موجودة في كل كبايننا .

FEATURES

- 1,5 mm Galvanized Sheet Walls
- 18 mm Radius Laminate Cars
- Stainless Steel Cars of 304 Quality
- Complete Laser Ceiling
- Various Color and Pattern Options for Glass Cars
- Range of Glass and LED Ceilings
- Antibacterial PVC Floor
- Range of 20mm Natural Granite Floors
- Range of Various Floors
- Lighting and Fan Ready for Operation
- Special Bends and Wedges for Vibration Preventing
- Optional Case Packing

ОСОБЕННОСТИ

- Толщина оцинкованного листа кабины 1,5 мм
- Толщина стен кабины 18 мм
- Кабины из нержавеющей стали 304 качества
- Энергосберегающий светодиодный потолок
- Возможность выбора различных цветов и узоров для стеклянных кабин
- Возможность выбора различного дизайна светодиодных потолков
- Антибактериальные и износостойкие ПВХ-покрытия для пола
- Возможность выбора натуральных гранитных полов толщиной 20мм
- Возможность выбора различного дизайна для полового покрытия
- Вентиляция кабины
- Специальные гасители для предотвращения вибрации
- Упаковка оборудования для транспортировки на выбор клиента
- Прогрессивный механизм безопасности – наш стандарт во всех кабинах.



BELEN



KAPADOKYA



NARİN



KÜRRE



GİLAN



BERCESTE



FUTURE

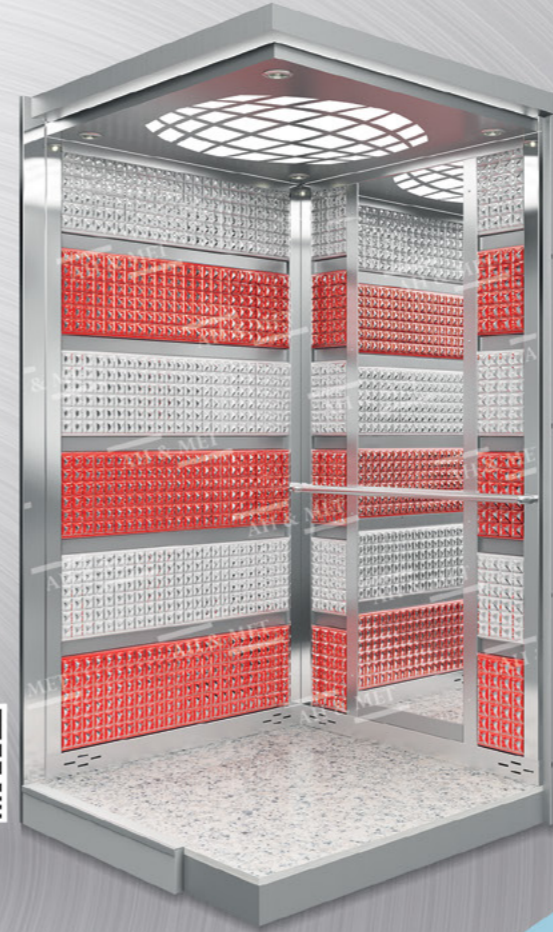

DİDAR



DORU



SAHRA



SAFRAN



REDİF



SENTE



VERONA



ZEBRA



MOZART





TILSIM



SİMA



SÖRF



BELKIS



LİRİK



VADİ



ORKİDE



MANSURE



RUBAİ



SEMAİ



MANAS



REAL



ELDORA



FİRÜZE



DİZÖR



KRAFT



BİLLUR

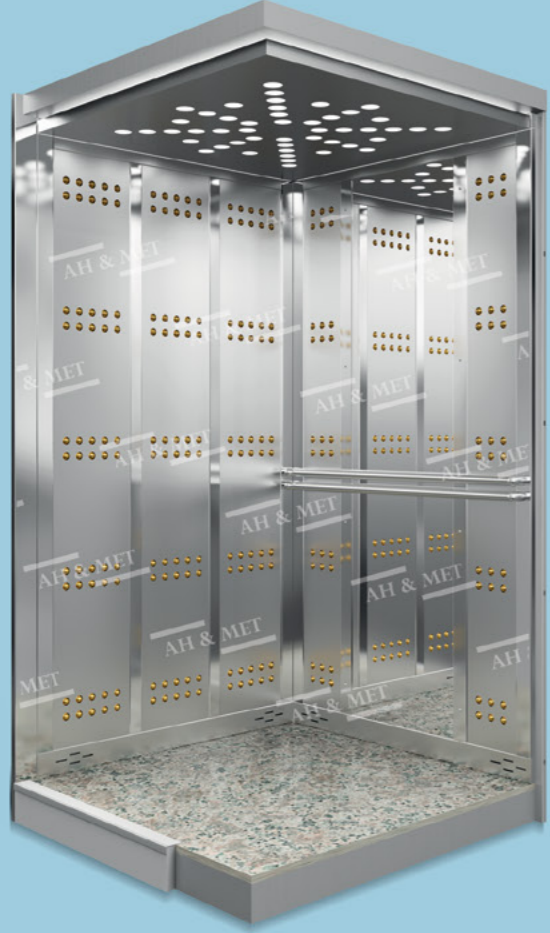

KRİSTAL

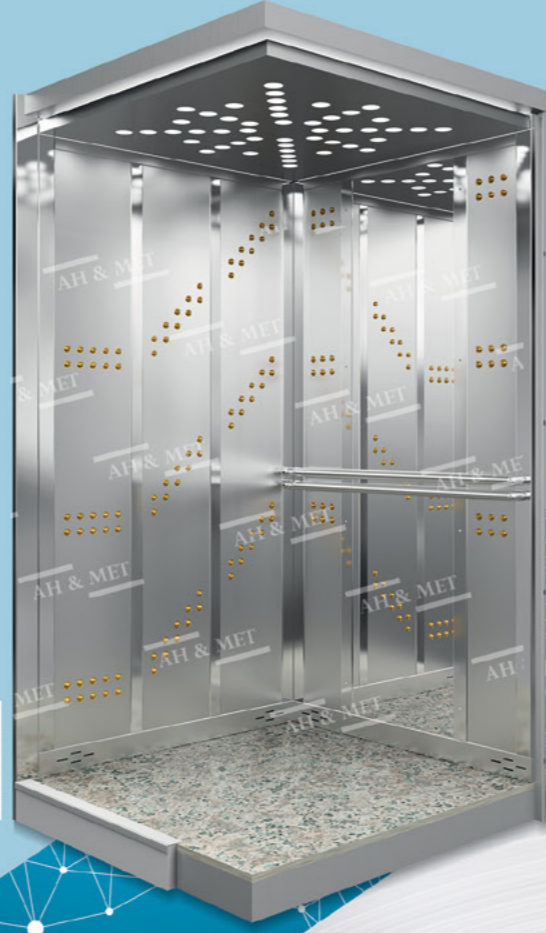

ELMİNA



TASVİR



CEVHER



ZEN



HAWAİ



OCEAN

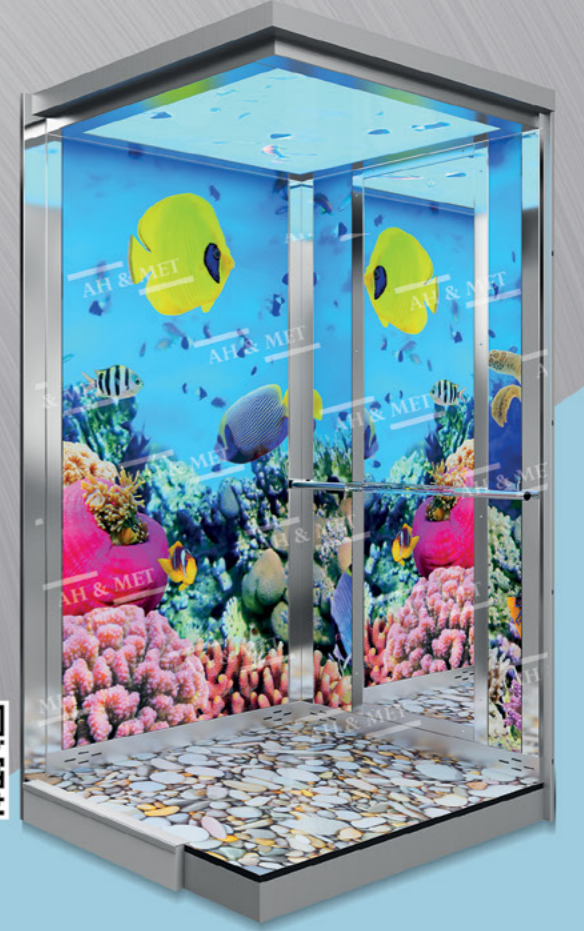

GARDEN



SUNLIGHT

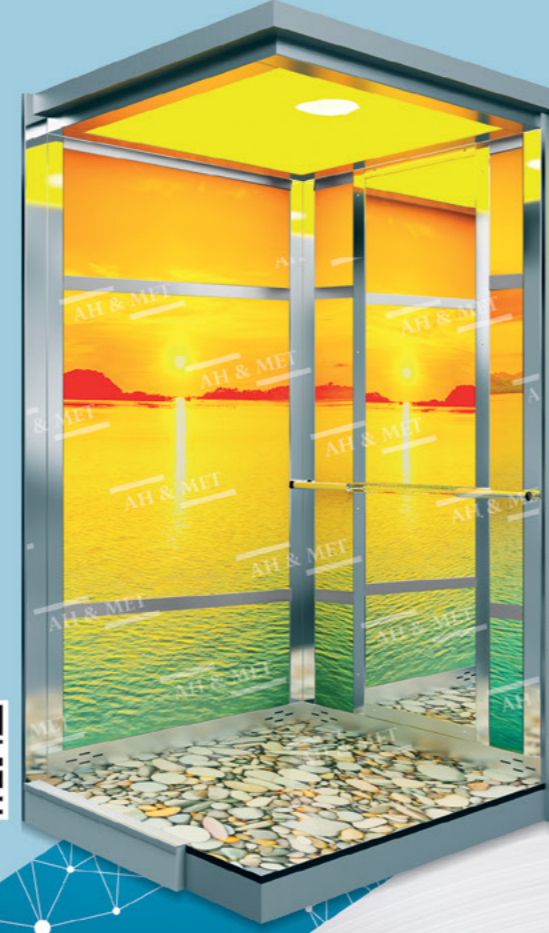

MENEKŞE



DELTA



TOROS



DOLPHIN



ZAMİR



RUYET



ALMİNA



ZÜMRÜT



PENTA



ALYANS



SERENCAM



TURKUAZ



SELÇUKLU



OSMANLI



EBRULİ



BAROK

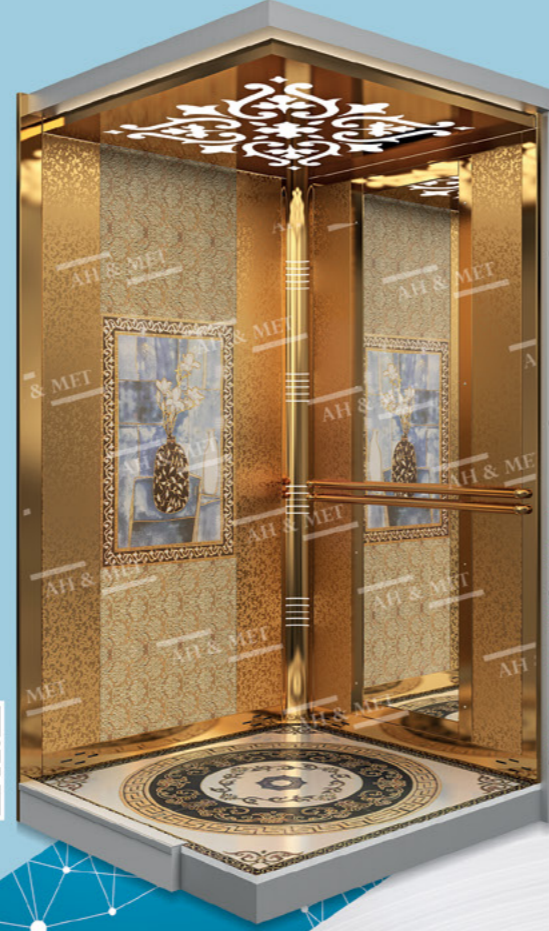

TROPIC

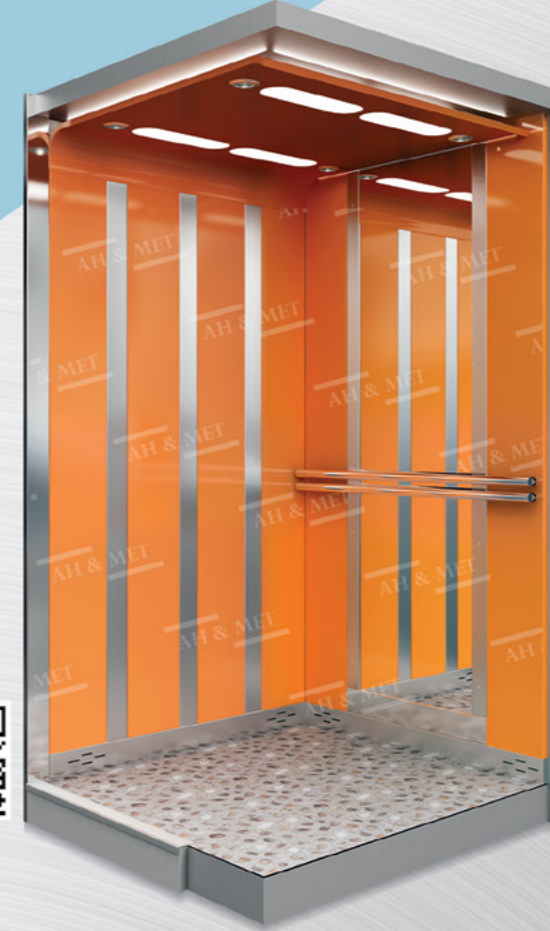

GREEN



BADE

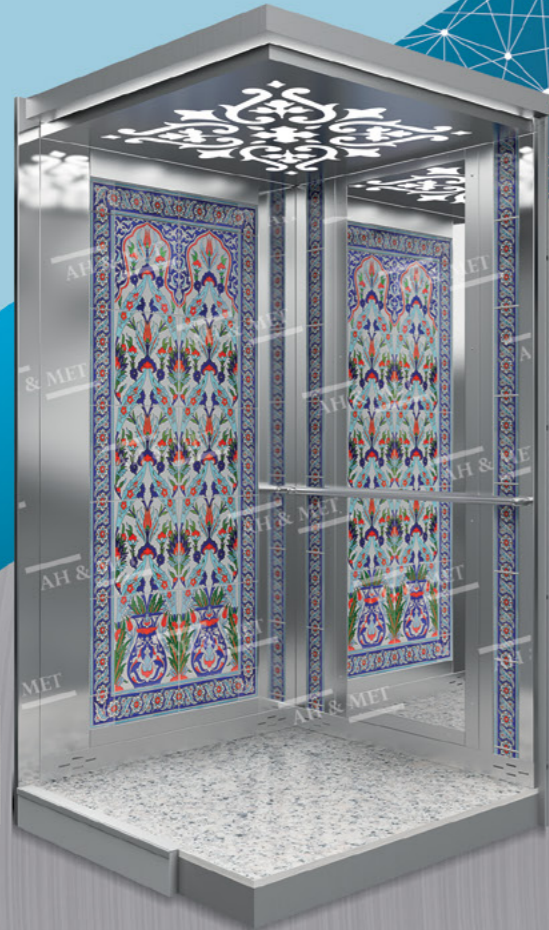

SUDE



AKAY



TUAL



PANORAMİK



SAFİR



SEDYE



OTOMATİK KAPILAR
AUTOMATIC DOORS



OTOMATİK KAPILAR
AUTOMATIC DOORS

AH & MET®

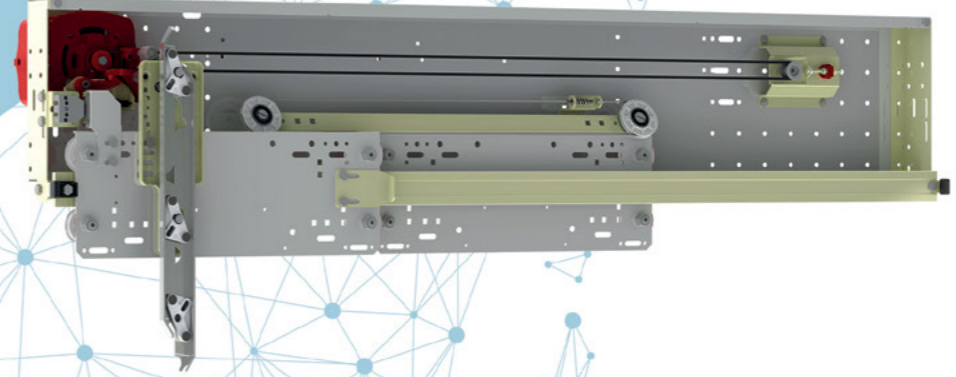
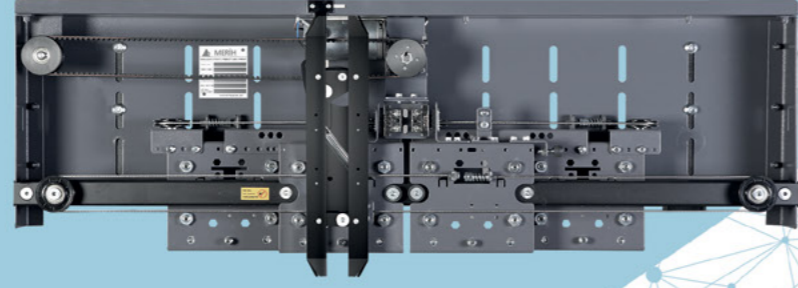
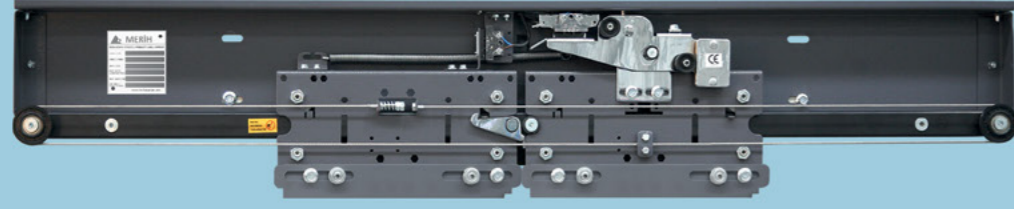

Fermator
AUTOMATIC DOORS FOR LIFTS

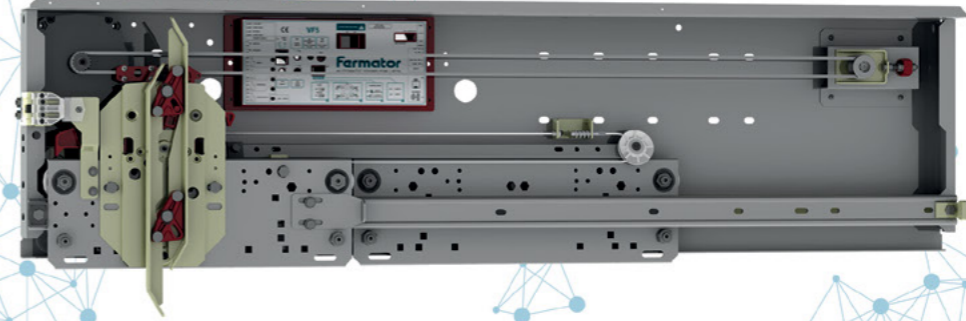



OTOMATİK KAPILAR
AUTOMATIC DOORS

AH & MET®

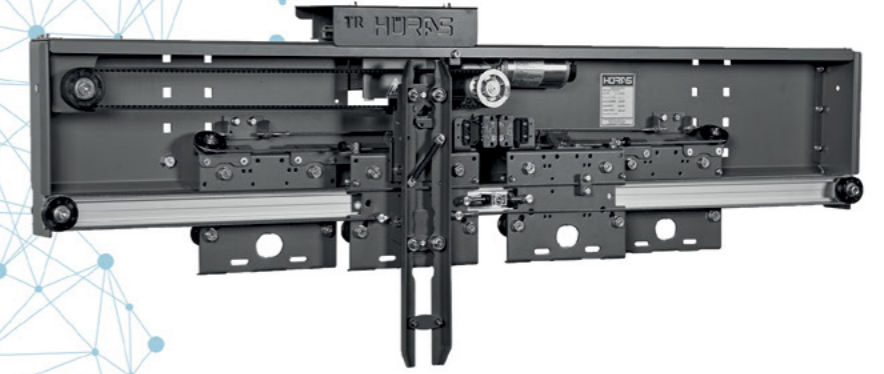
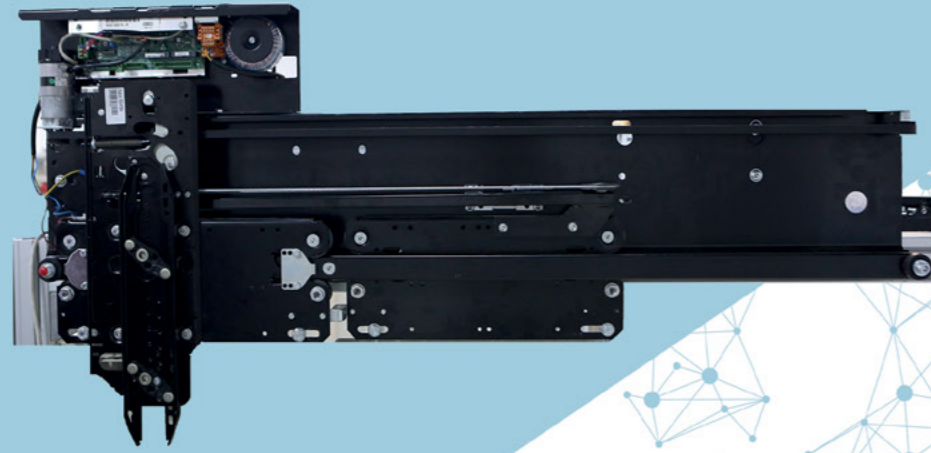
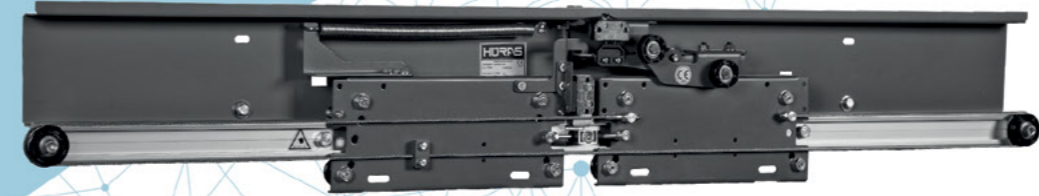

HÜRPA

PROLIFT
automatic doors for lifts

ASRO
Makina Asansör İmalat San. ve Tic.



**KAPILAR
DOORS**

A-4250



A-4251



A-4252



A-4253



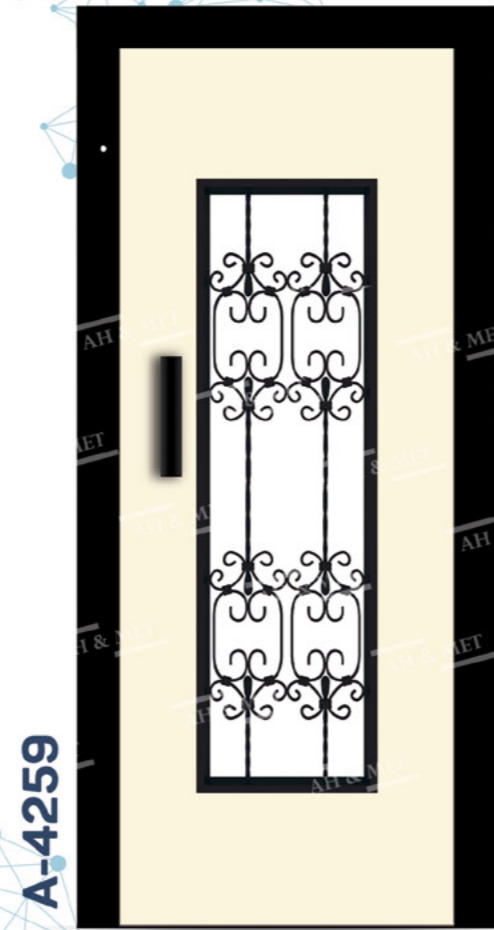
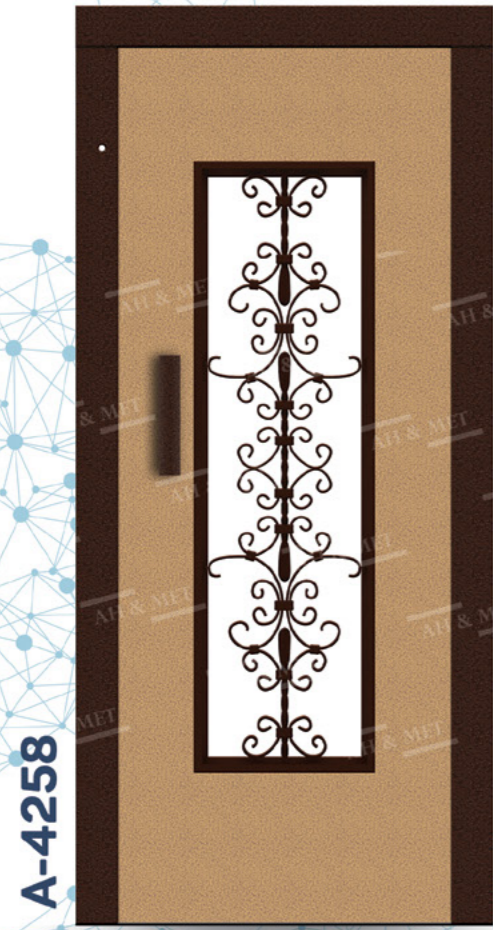
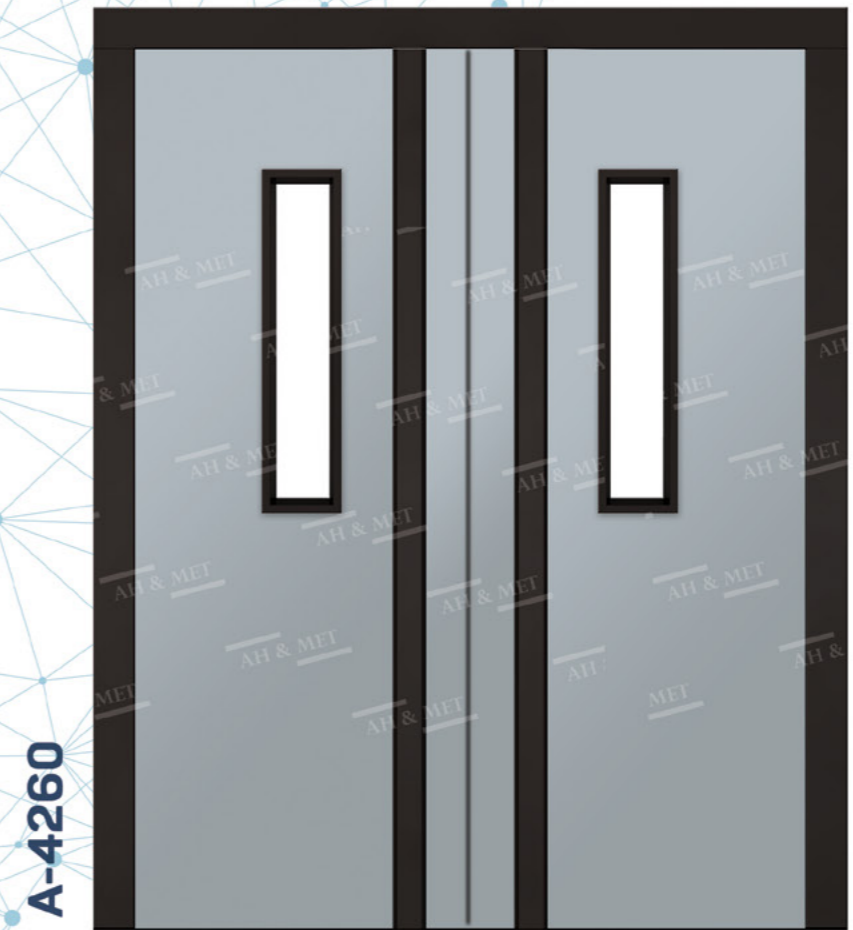
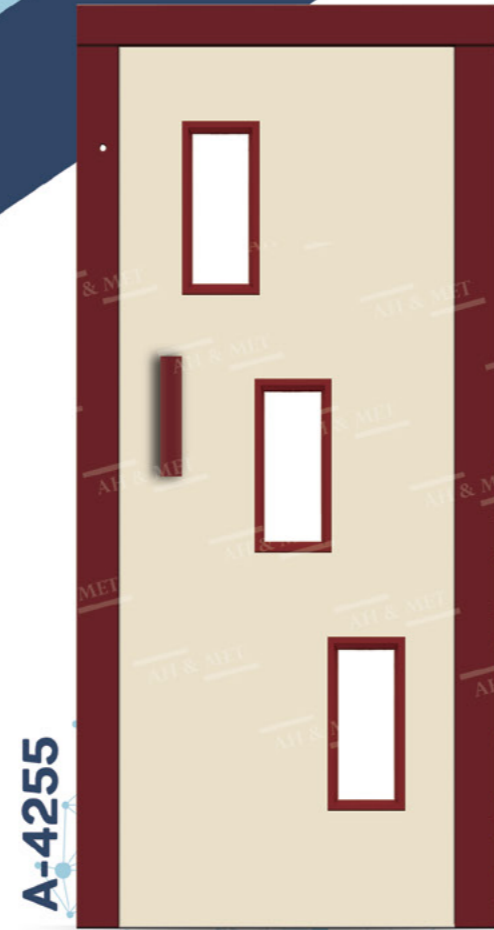

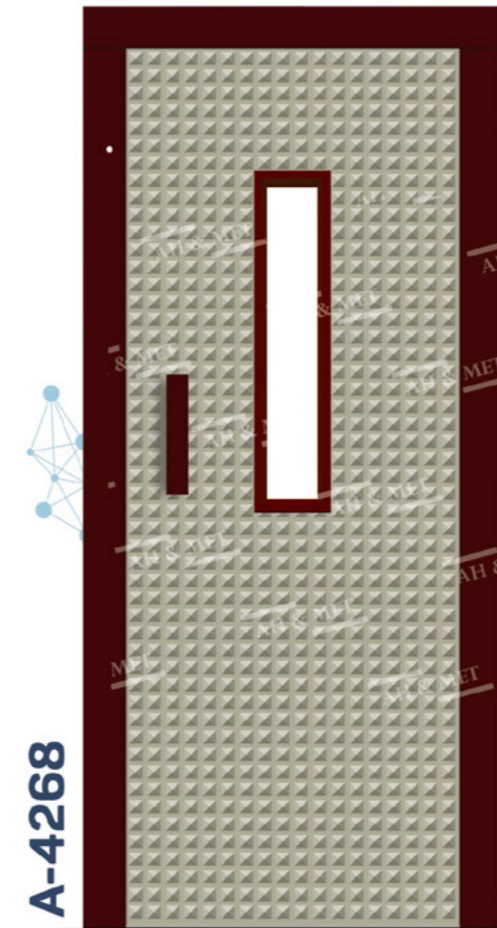
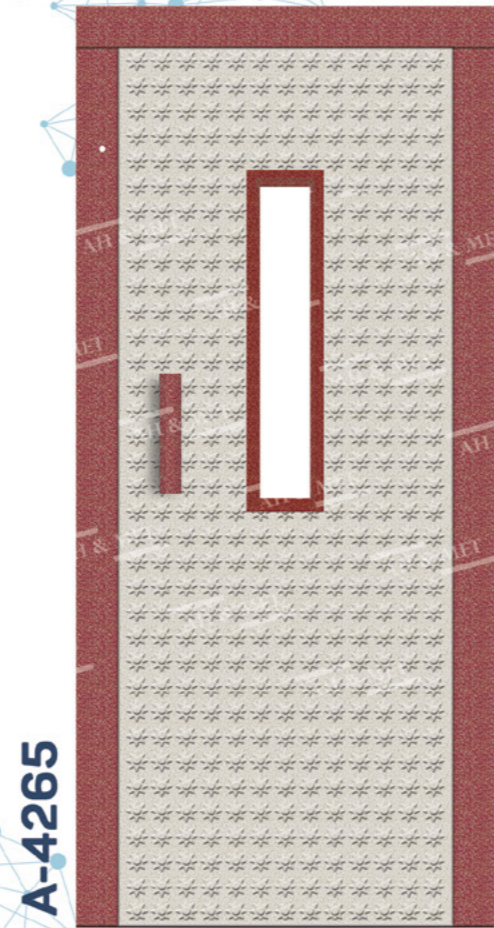
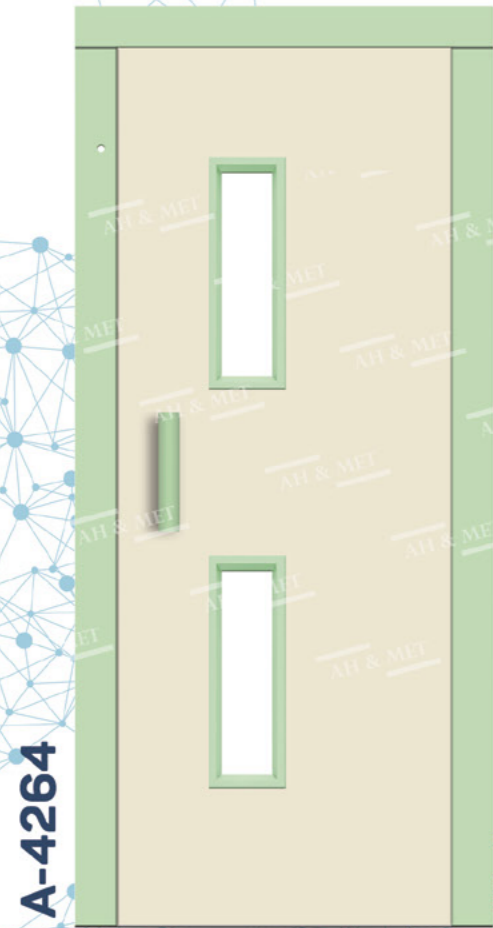
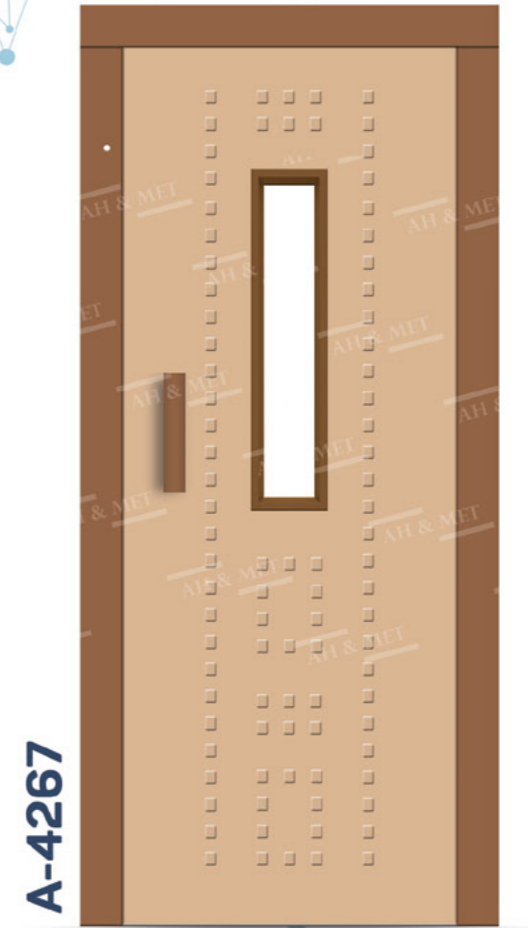
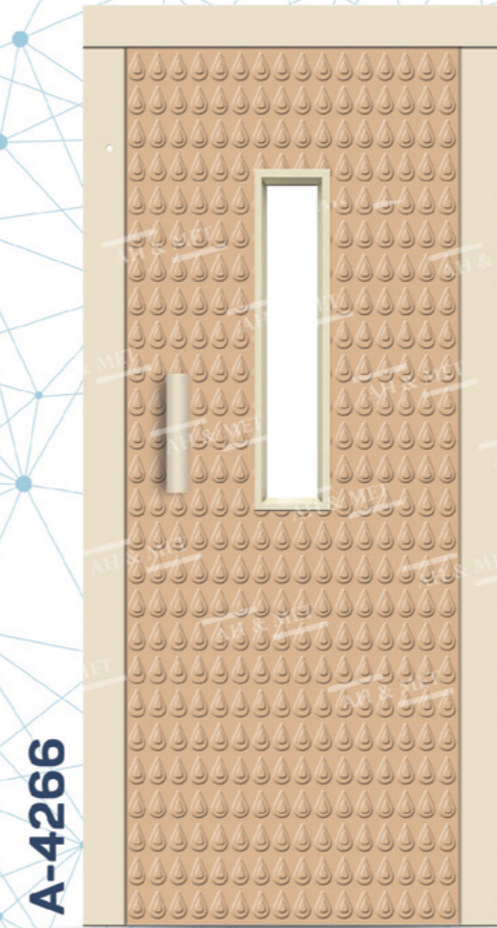
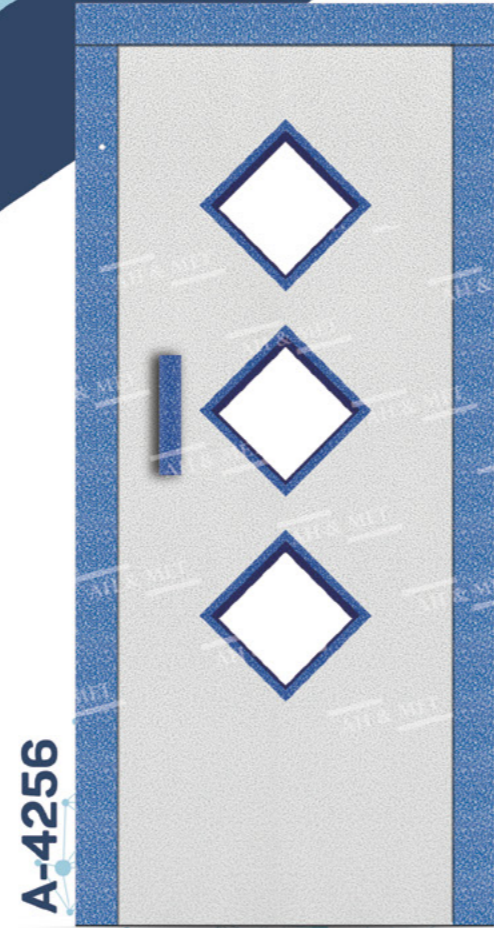
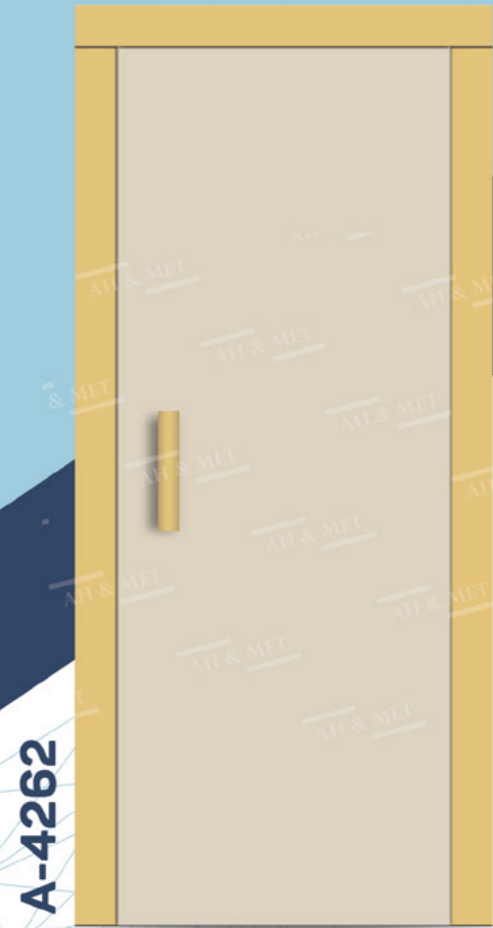



A-4270



A-4271



A-4272



A-4257

SİSTEMLER
SYSTEMS



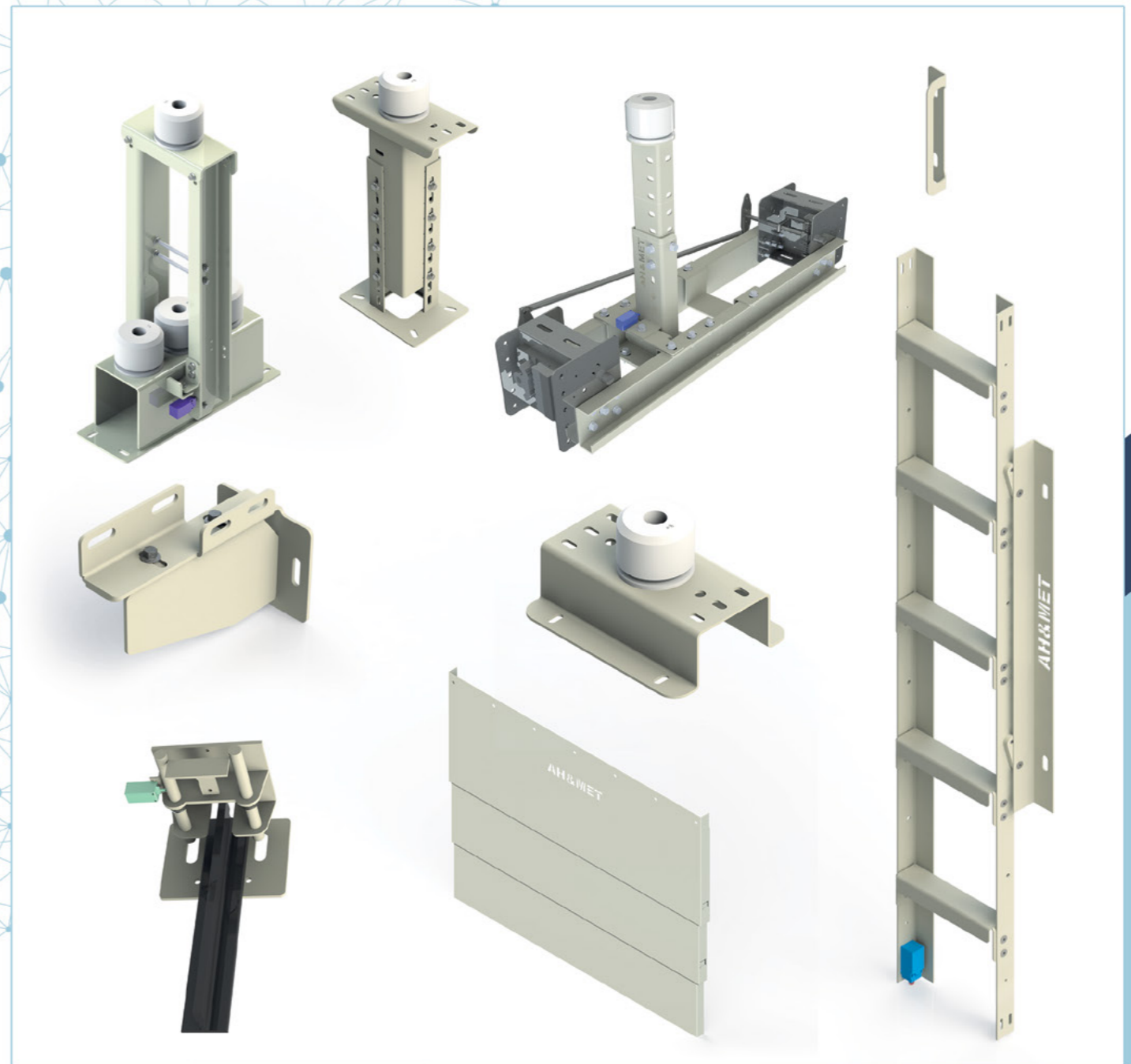
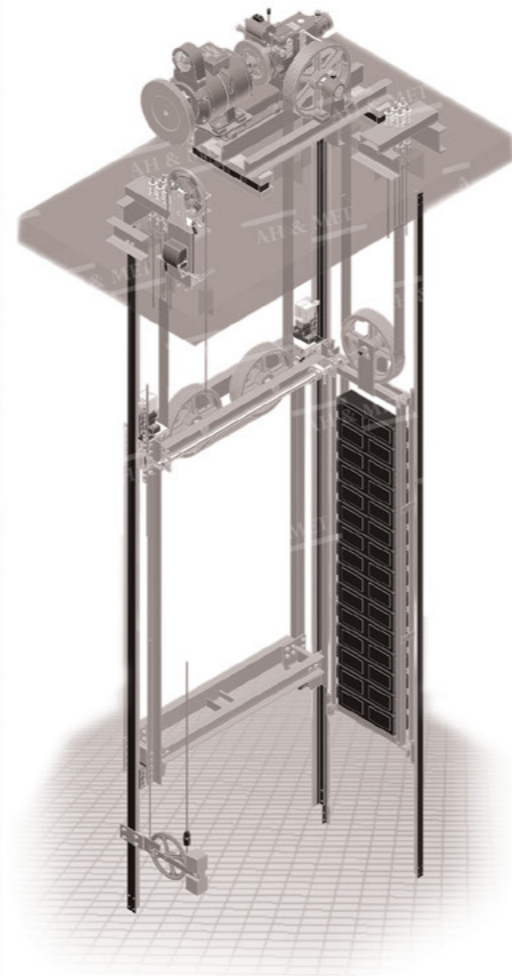
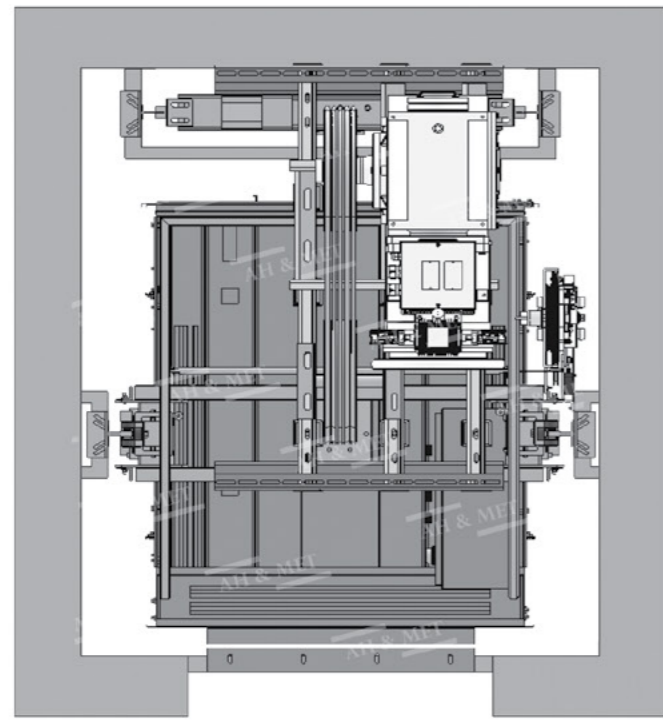
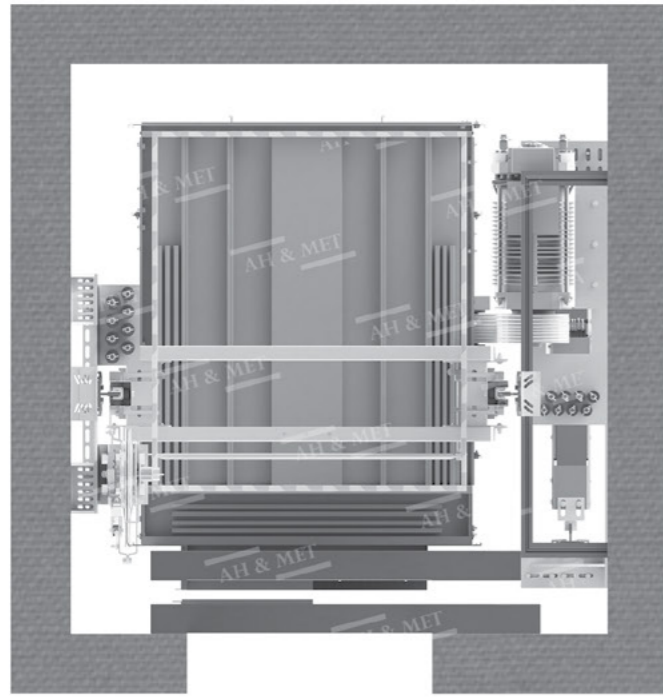

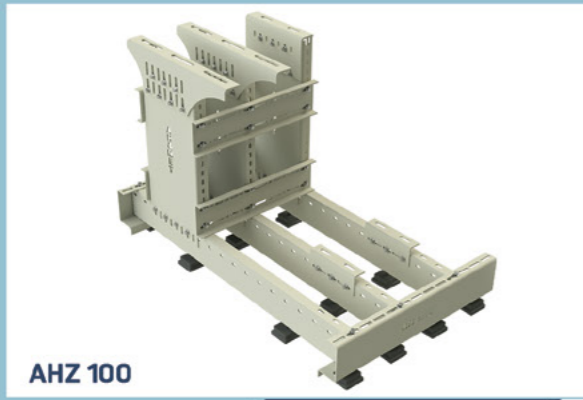

AHZ 100

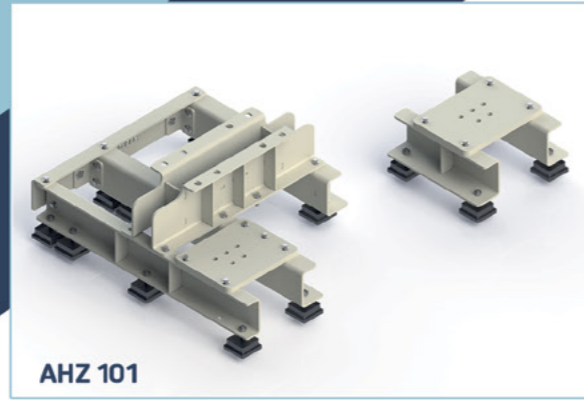

AHZ 101

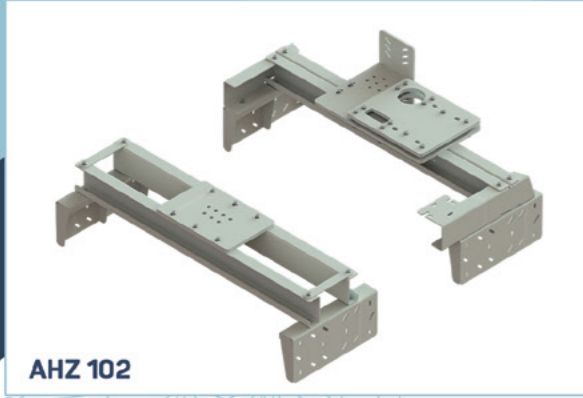

AHZ 102

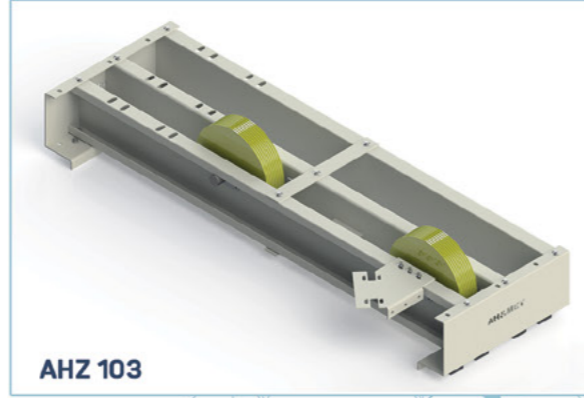

AHZ 103

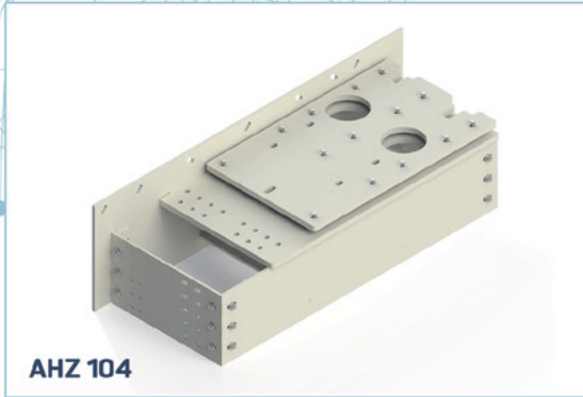

AHZ 104

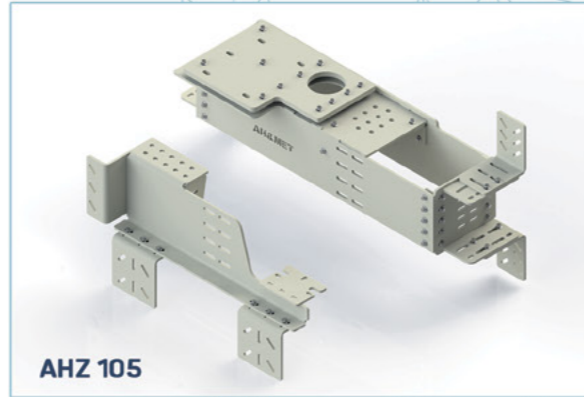

AHZ 105

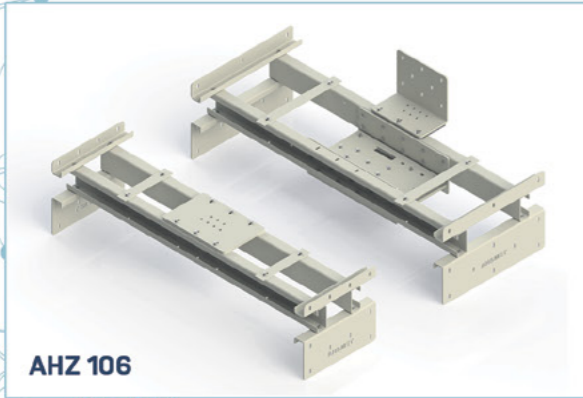

AHZ 106



AHZ 107



AHZ 108

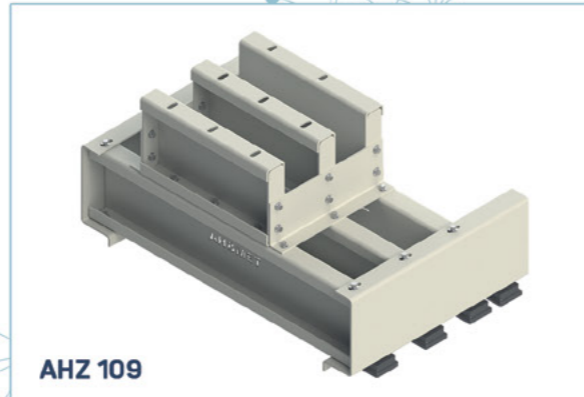

AHZ 109

BUTONLAR BUTTONS

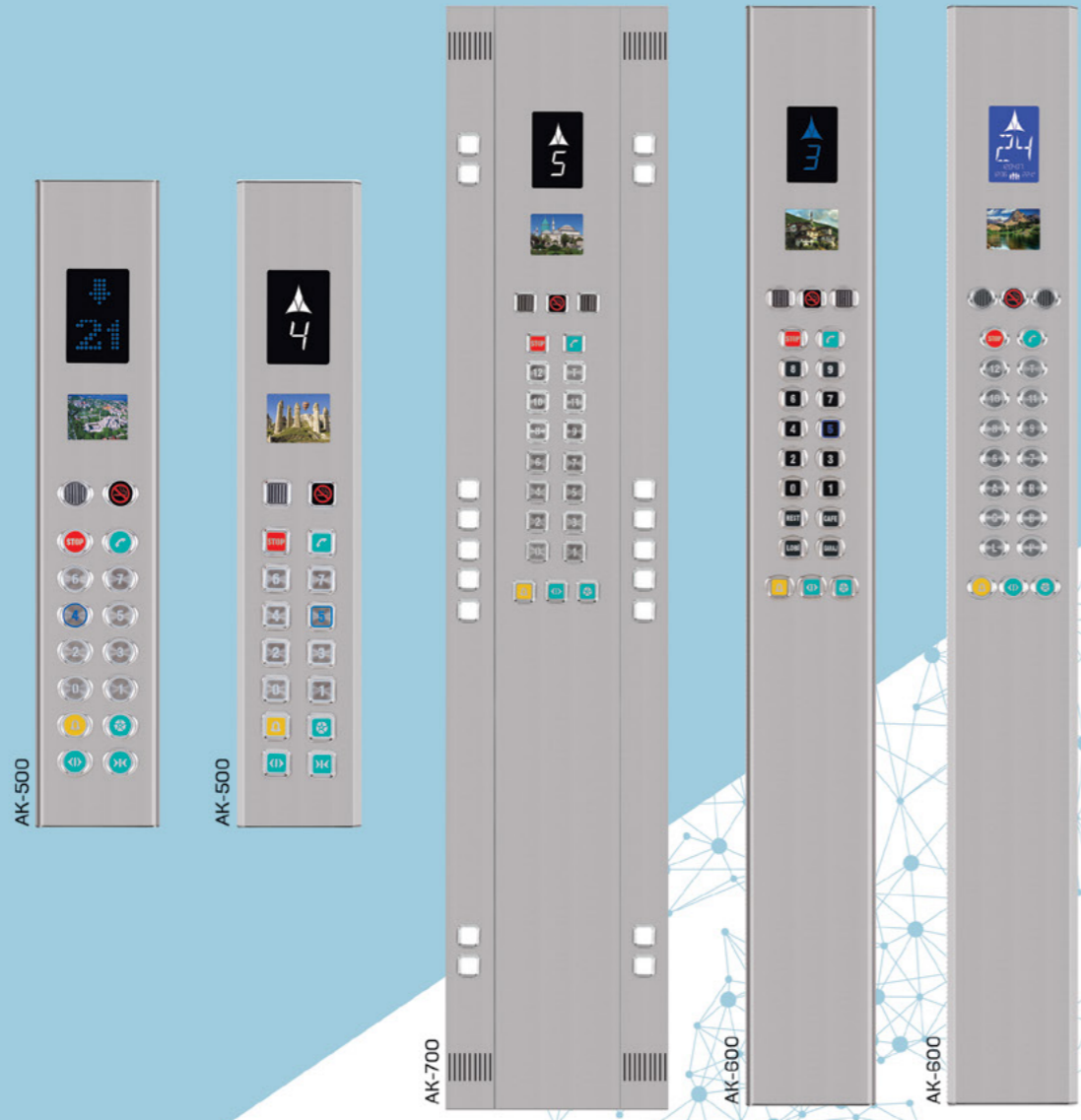

aktel®



WISEROL

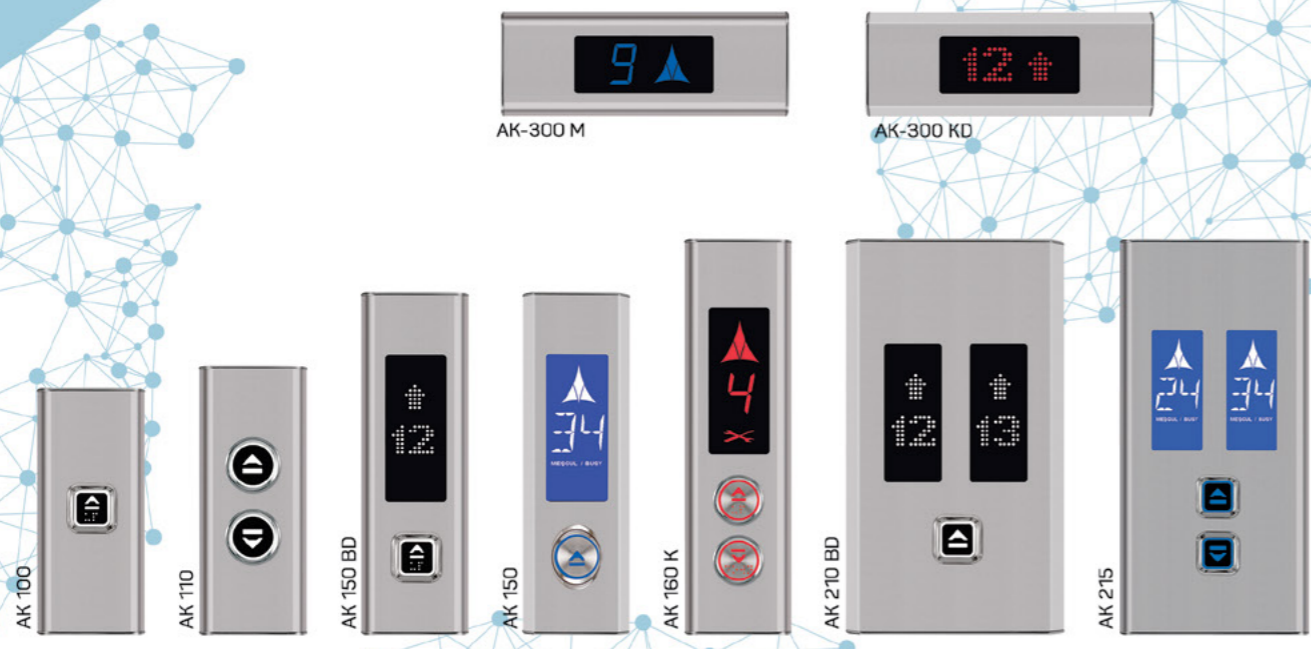



BUTONLAR BUTTONS

AH & MET®



BUT - SAN
Lift Fixtures

ametal
asansör malzemesi

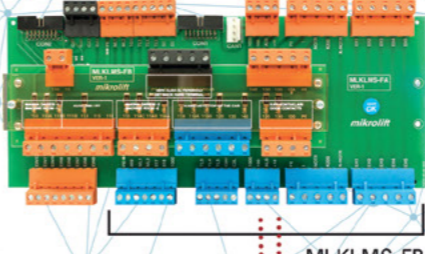
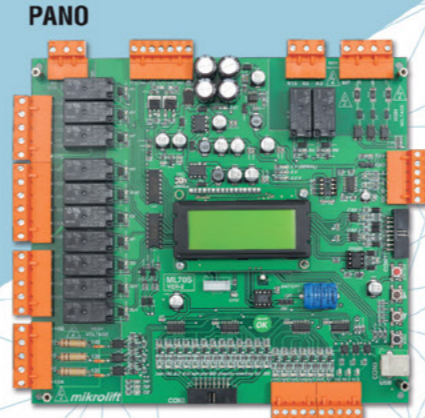
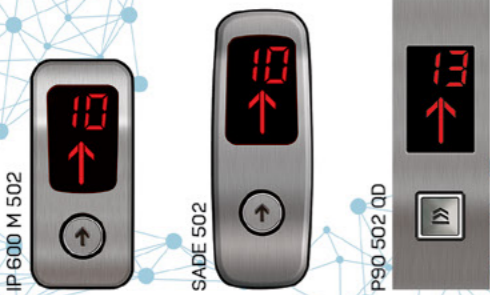

MLKMS-FB

REVİZYON KUTUSU

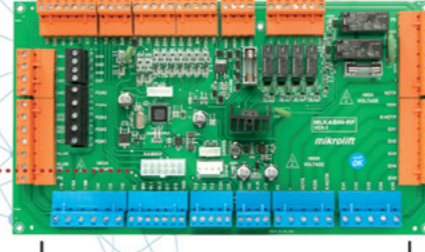

MLKABIN-RF

KABİN

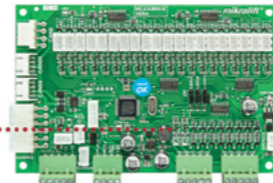

MLKABIN-K



MLTFT

ASANSÖR KONTROL KARTI

- Tam seri iletişim
- Kabin butonunda hassas kabin seviye ayarı
- EN81-1/2 + A3 standartlarına uygunluk
- 32 durak
- Detaylı arıza takibi (saat,tarih)
- Çift otomatik kapı desteği
- Kuyu kopyalama

LIFT CONTROLLER CARD

- Full serial communication
- Sensitive car level setting from the car buttons
- 32 floors
- Detailed fault tracking (hour,date)
- Double automatic door support
- Shaft learning

Seri tesisatta uygun fiyata yüksek performans, hatasız bağlantı, zamandan ve işçilikten tasarruf avantajı...
In serial wiring, high performance with affordable, connection without fault, save time and labor benefits from...



MLKAT-D4M



MLKAT-DS





MAKİNE MOTORLAR MACHINE MOTORS



AKIŞ



AKIŞ ZF



AKIŞ



ALBERTO SASSI

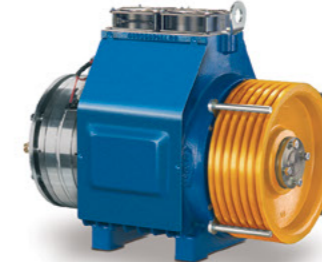

ALBERTO SASSI

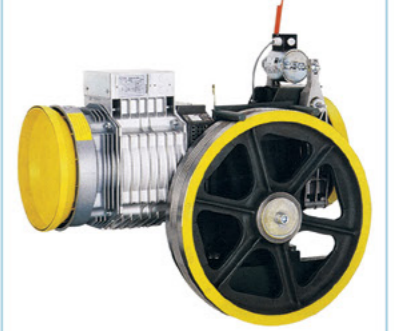

SCHINDLER



AKIŞ



AKAR



AKAR



MONTANARI



MONTANARI



SICOR



ÖZBEK



ASTES



EKER



WITTUR



WITTUR



GEM

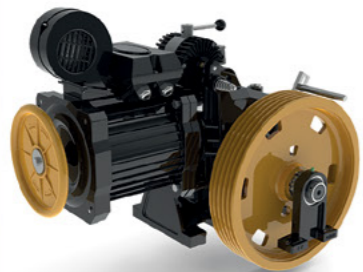

ARK



CLINDAS



CSAG



ZIEHL-ABEGG

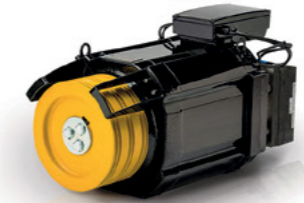

LAFERT



KARASAKAL

ÖZELLİKLER

- Yüksek kalite ve güvenlik
- Çift hızlı, VVVF hız kontrollü, Makine dairesiz, Hidrolik
- Kurtaran ve UPS seçenekleri
- Mikrolift , Arkel , Hedefsan kart seçenekleri
- SCHNEIDER , LG , ABB kontaktör sistemi
- 32 Durağa kadar ayarlanabilir
- 60 adet saat ve tarihli hata hafızası
- Alarm çıkışı
- Seri tesisat
- Seri haberleşme
- Elektrostatik kasa
- Tam otomatik çift kapı çalıştırma özelliği
- Deprem ve yangın sensörü girişleri
- Güvenlik devresinde kaçak akım rölesi
- Ayarlanabilir park durağı
- Karton ambalaj ile taşıma güvenliği
- Tüm panolarımıza bi-stabil ve mıknatıs dahildir
- Fleksibil kablo bağlantı noktası
- Elektrik kesintilerinde kabin içi acil aydınlatma sistemi
- Şifre korumalı programlama, izinsiz kullanıma karşı PUK kodu
- Sesli ikaz sistemi

FEATURES

- High quality and safety
- Two Speed, VVVF speed control, Roomless, Hydraulic
- Mikrolift , Arkel , Hedefsan quality of cards
- SCHNEIDER , LG , ABB contactor system
- Adjustable up to 32 stops
- 60 errors memory with time and date
- Serial installation
- Alarm exit
- Adjustable park stop
- Serial Communication
- Electrostatic case
- Full automatic double door operation feature
- Earthquake and fire sensor input
- Residual voltage in security circuit
- Wide range of emergency rescue systems and UPS
- Transportation security with carton packing
- All panels include bi-stable and magnet
- Flexible cable connection point
- In-cabin lighting system in case of power cut
- Password protection program, PUK code against unauthorized use
- Voice warning system

ОСОБЕННОСТИ

- Высокое качество и безопасность
- Двухскоростной, VVVF-контроль скорости, Без машинного помещения, Гидравлический
- Широкий выбор аварийно-спасательных систем и UPS
- Выбор платы системы управления, различных фирм: МИКРОЛИФТ, АРКЕЛ, НЕДЕФСАН
- Выбор системы контакторов LG, ABB, SCHNEIDER
- Регулируется до 32 остановок
- Память на 60 ошибок с датой и временем
- Аварийный выход
- Серийная установка
- Последовательная связь
- Система звукового сигнала предупреждения
- Полная автоматизация двойных дверей
- Выход для датчика сенсора при землетрясениях и пожаре
- Бесперебойное напряжение в схеме защиты
- Регулируемая остановка кабины
- Электростатическая коробка
- Прочная упаковка для безопасной транспортировки
- Все панели оснащены датчиком точной остановки лифта
- Точка подключения подвесного кабеля
- Аварийная система освещения кабин в случае перебоя электропитания
- Программа системы управления защищена паролем, а так же PUK-код против несанкционированного использования

المواصفات

- إمكانية قفل البرنامج بـ كود PUK لمنع الاستخدام الغير مرغوب
- التركيب التسلسلي .
- الاتصال التسلسلي .
- ميزات تشغيل المصعد ثنائي الباب الأتوماتيكي .
- مدخل لمساح الحريق والفزات الأرضية (سينسور) .
- تتبع تسريب التيار في دورة الحماية .
- إمكانية ضبط توقف المصعد (تجريش) .
- الصندوق مطلي بطلاء استاتيكى .
- تأمين توصيل المعدات أثناء النقل بالتغليف الكرتوني .
- لمغناطيس و stable-bi موجود في كل لوحاتنا .
- نقطة ربط الكابلات المرنة
- نظام إضاءة داخل الكابينة عند انقطاع التيار الكهربائي .
- خروج الإنذار
- نظام التحذير الصوتي .
- جودة مرتفعة وحماية عالية .
- بدون غرفة ماكينة , سرعتين , سرعة VVVF , هيدروليكي .
- خيار جهاز الإنقاذ و UPS .
- خيارات الكرت الأم MIKROLIFT , ARKEL , HEDEFSAN .
- خيارات نظام القواطع (كونتكتور) LG , ABB , SCHNEIDER .
- إمكانية الضبط حتى 32 موقف .
- ذاكرة لتسجيل الأخطاء بسعة استيعابية تصل حتى 60 خطأ بالوقت و التاريخ .





KUMANDA PANOLARI CONTROL PANELS



HIZ KONTROLLÜ KURTARANLI PANO
VVF CONTROL PANEL



HIZ KONTROLLÜ KURTARANLI PANO
VVF CONTROL PANEL

mikrolift

HEDEFSAN

ARKEL

LS

Fuji Electric
Innovating Energy Technology

REVIZYON SETİ / REVISION SET



MIKROLIFT ML70S

REVIZYON SETİ / REVISION SET



MIKROLIFT ML40P

REVIZYON SETİ / REVISION SET



ARKEL FX16

AKSESUARLAR ACCESSORIES

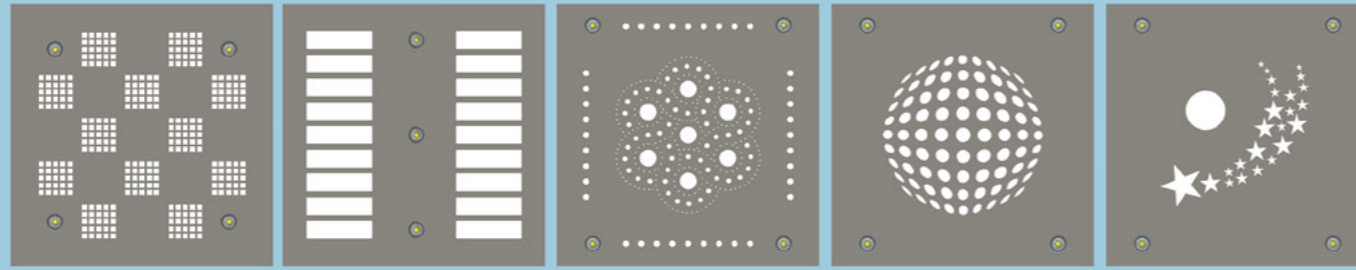

T-37 T-38 T-39 T-40 T-41

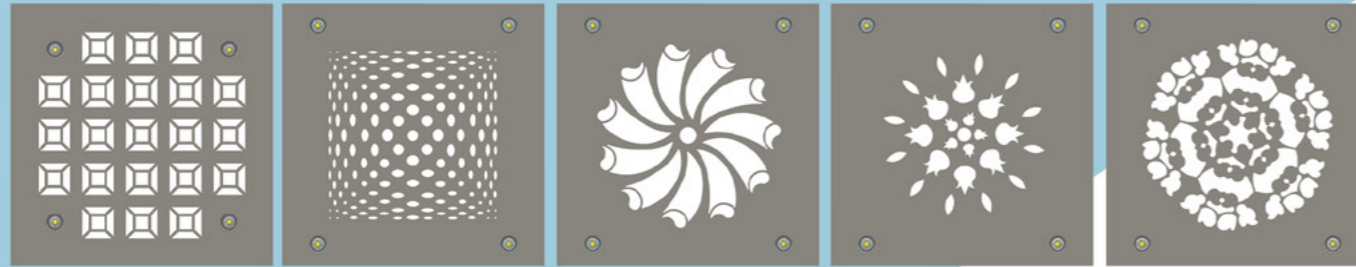

T-42 T-43 T-44 T-45 T-46



T-47 T-48 T-49 T-50 T-51



T-52 T-53 T-54 T-55 T-56

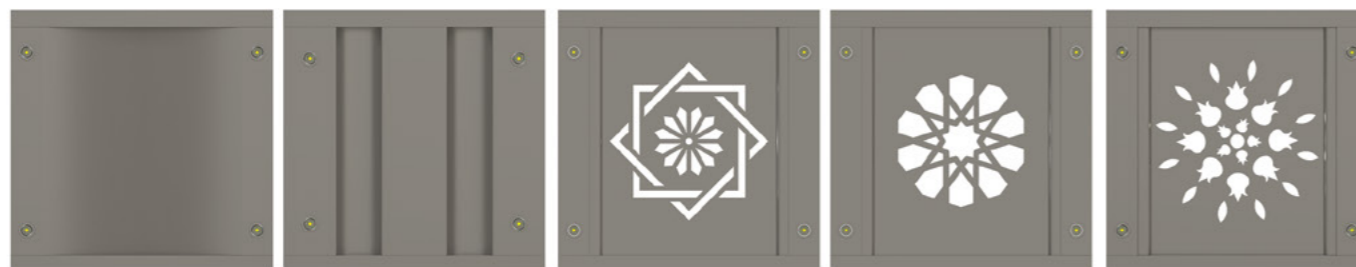

T-57 T-58 T-59 T-60 T-61



STAR GALAXY TAN BROWN BLUE PEARL VERDE GUATEMALA BALTIC BROWN

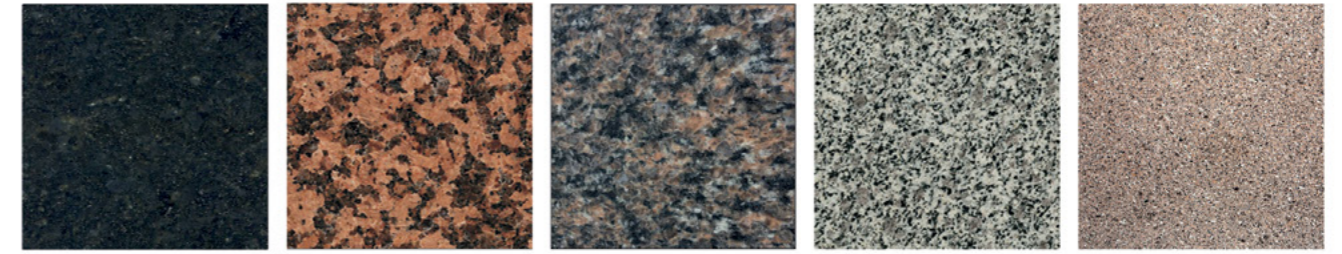

NOVA BLACK BALMORAN RED DAKOTA BROWN HISAR YAYLAK CREMA LAL



ROSA MÍNHO ROSA PORRINHO AKSARAY YAYLAK COLONIAL WHITE BIANCO PERLA



CIMSTONE SINES CIMSTONE OASIS CIMSTONE LAPLAND CIMSTONE ARCADIA CIMSTONE MIRAT



TB-17 TB-18 TB-19 TB-20 TB-21



TB-06 TB-07 TB-16 TB-09 TB-10

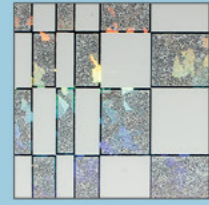

576

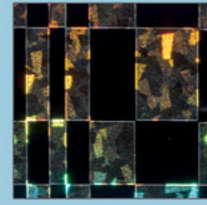

577



694

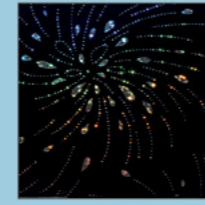

695

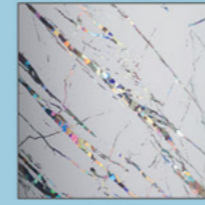

395

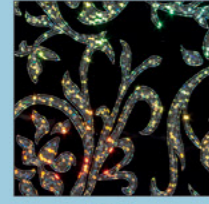

398

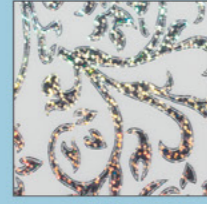

397

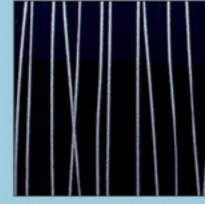

170

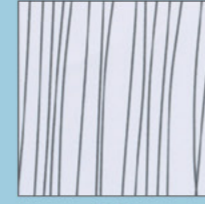

143



578



142

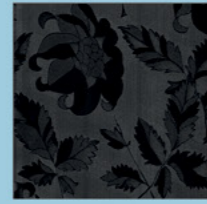

169

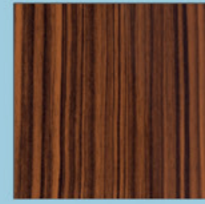

ABANOZ

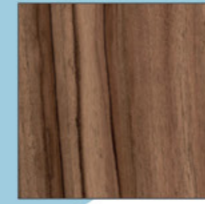

MİLANO

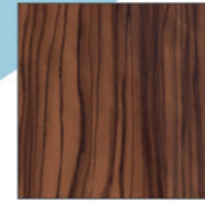

LATİN CEVİZ



ZEYTİN

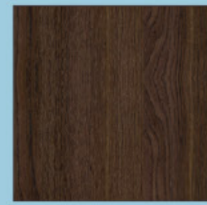

CHESTERFIELD MEŞE

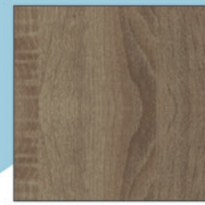

ALMAN MEŞE



BUDAK MEŞE



RAFIA



SATİNE



AYNA

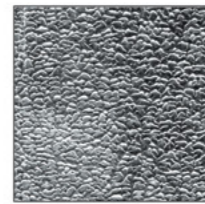

DERİ

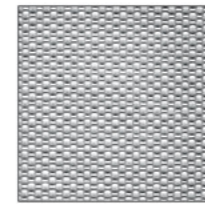

NOKTA

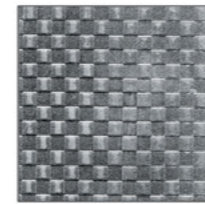

KARE



DM-05



DM-15

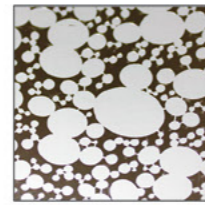

DM-16



DM-23

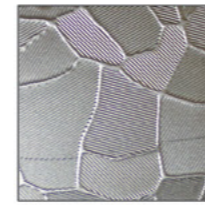

DM-MZK



DG-03



DG-07

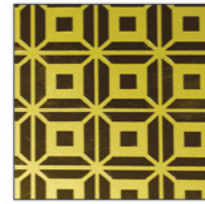

DG-10



DG-20

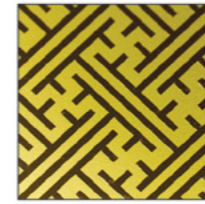

DG-26



DB-01



DB-02



DB-03



DB-04

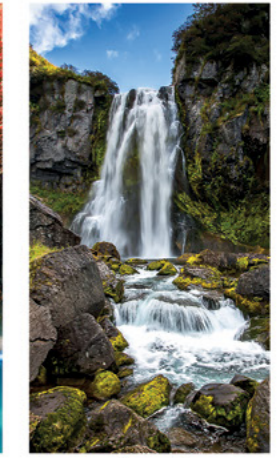

DB-05



DB-06



DB-07



DB-08



DB-09



DB-10



DB-11



DB-12

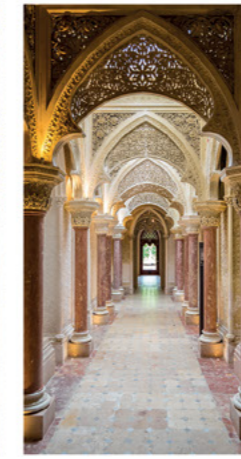

DB-13



DB-14



DB-15



DT-01



DT-02



DT-03



DT-04



DT-05

YEDEK PARÇA
SPARE PARTS

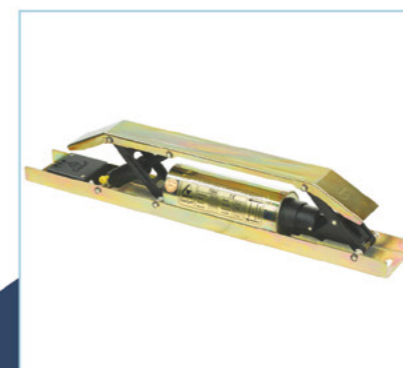
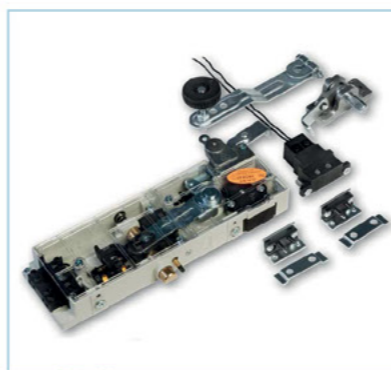

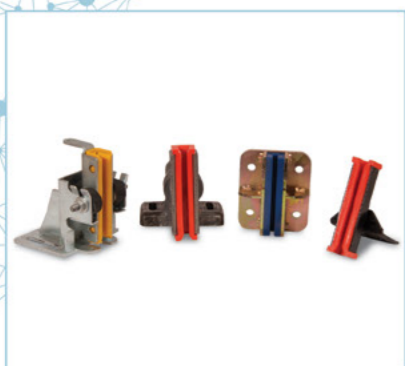
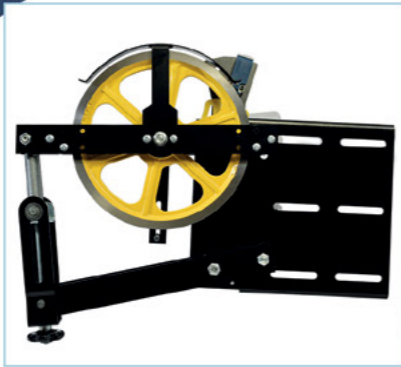



AH & MET[®]

AH-MET ASANSÖR SANAYİ VE TİC. LTD. STİ.

A: 3. Organize San. Bölgesi T.Ziyaeddin Akbulut Cad. No:16 Konya / TÜRKİYE
T: + 90 332 237 99 05 www.ahmetasansor.com.tr
F: + 90 332 237 49 18 bilgi@ahmetasansor.com.tr