

An aerial photograph of a dense city skyline, likely Hong Kong, featuring numerous skyscrapers and residential buildings. A blue curved line starts from the top center, goes down to a light blue rectangular box containing the text 'AH & MET' with a registered trademark symbol, then curves down and left across the middle of the image, and finally curves down and right towards the bottom left. The sky is a clear, pale blue with light clouds.

AH & MET[®]

FOUNDED IN 1998, OUR COMPANY PACKAGE LIFTS AND EQUIPMENT IS ONE OF TURKEY'S LEADING COMPANY IN SALES. BY CREATING A WIDE SERVICE RANGE FROM EAST TO WEST AND NORTH TO SOUTH IN DOMESTIC MARKET OUR COMPANY HAS EXTENDED THE RANGE TO 67 COUNTRIES TO THANKS TO CUSTOMERS TRUST IN RECENT YEARS.

WE PRODUCE CABIN , CONTROL SYSTEMS , DOORS , SUSPENSION AND CHASSIS ACCORDING TO SPECIAL SHAFT IN 20.000 M² PLACE FACTORY IN INDUSTRY CENTER OF TURKEY IS KONYA . ALL PRODUCTS HAVE CERTIFICATE EUROPEAN STANDARD (CE) , RUSSIAN STANDARD (EAC) AND UKRANIAN CERTIFICATE.

OUR COMPANY IS WORKING WITH HIGH QUALITY AND TIMELY DELIVERY PRINCIPLE AT THE SAME TIME TOO MANY DOMESTIC AND FOREIGN BRAND PRODUCTS SELLING. CONTINUOUSLY TRACKING PROGRESS IN OUR COUNTRY AND IN THE WORLD OUR COMPANY WITH ITS YOUNG AND DYNAMIC STAFF TARGETED AT TECHNOLOGICAL DEVELOPMENT AND INNOVATIONS , CUSTOMERS ORIENTED SERVICE CONCEPTION MAKES FIRM STEPS TO THE FUTURE IN THE LIGHT OF THE PAST AND WILL CONTINUE TO BE INVOLVED IN THE SECTOR SIDE BY SIDE WITH ITS CLIENTS.

НАША КОМПАНИЯ БЫЛА ОСНОВАНА 1998 ГОДУ И ЗАНИМАЕТСЯ ПРОИЗВОДСТВОМ ЛИФТОВОГО ОБОРУДОВАНИЯ, А ТАК ЖЕ КОМПОНЕНТОВ К ДАННОМУ ОБОРУДОВАНИЮ. ЯВЛЯЯСЬ ОДНИМ ИЗ ЛИДЕРОВ ПО ПРОИЗВОДСТВУ И ПРОДАЖЕ В ЭТОЙ ОТРАСЛИ; МЫ ПРЕДОСТАВЛЯЕМ КАЧЕСТВЕННЫЕ УСЛУГИ КАК ВНУТРИ ТУРЕЦКОЙ РЕСПУБЛИКИ, ТАК И БОЛЕЕ 100 ЗАРУБЕЖНЫМ ФИРМАМ ИЗ 67 СТРАНЫ.

ЗАВОД НАХОДИТСЯ В ГОРОДЕ КОНЬЯ ТУРЕЦКОЙ РЕСПУБЛИКИ И ИМЕЕТ 20 000 КВАДРАТНЫХ МЕТРОВ. ПРОИЗВОДСТВО ОСНАЩЕНО ПОСЛЕДНИМ ТЕХНОЛОГИЧЕСКИМ ПАРКОМ ОБОРУДОВАНИЯ И ПРОИЗВОДИТ ТАКИЕ КОМПОНЕНТЫ КАК: ДВЕРИ, КАБИНЫ, СТАНЦИИ УПРАВЛЕНИЯ И СПЕЦИАЛЬНЫЕ РАМЫ ДЛЯ ШАХТЫ. ВСЯ ПРОДУКЦИЯ ПРОИЗВОДИТСЯ СТРОГО ПО ЕВРОПЕЙСКОМУ (CE) И ЕВРАЗИЙСКОМУ (EAC) СТАНДАРТУ И ВЛАДЕЕТ СЕРТИФИКАТАМИ РАЗЛИЧНЫХ СТРАН. ТАКЖЕ ВЫ МОЖЕТЕ ПРИОБРЕСТИ У НАС КАЧЕСТВЕННУЮ ПРОДУКЦИЮ ИЗВЕСТНЫХ ЕВРОПЕЙСКИХ И ТУРЕЦКИХ МАРОК ПО ПРИЕМЛЕМЫМ ЦЕНАМ И СВОЕВРЕМЕННОЙ ДОСТАВКОЙ.

МЫ ДИНАМИЧНО РАЗВИВАЮЩАЯ ФИРМА С ПРОФЕССИОНАЛЬНЫМИ КВАЛИФИЦИРОВАННЫМИ КАДРАМИ ПОСТОЯННО ИННОВАЦИОННО-МОДЕРНИЗИРУЯ СВОЮ ПРОДУКЦИЮ УВЕРЕННО ШАГАЕМ В ПЕРЕД, КАЧЕСТВО, НАДЕЖНОСТЬ И БЕЗОПАСНОСТЬ ПРОДУКЦИИ - ЭТО ОСНОВНОЙ ПРИОРИТЕТ ПОЛИТИКИ НАШЕЙ КОМПАНИИ.

منذ عام 1998 تعد شركتنا إحدى الشركات التركية الرائدة في مجال بيع المصاعد الكاملة وكامل مستلزماتها . من خلال إنشاء شبكة خدمات واسعة من الشمال إلى الجنوب ومن الشرق إلى الغرب في السوق المحلية ، استطاعت شركتنا أن توسع نطاق خدماتها لتشمل 67 دولة في السنوات الأخيرة ، لتكسب بذلك ثناء وثقة العملاء .

نحن ننتج الكبائن ولوحات التحكم والأبواب الأتوماتيكية والنصف أوتوماتيكية والتعاليق والشاسيهات ، في مساحة 20.000 متر مربع من مدينة قونيا التي تعد أكبر مركز صناعي في تركيا .

جميع منتجاتنا حائزة على شهادات المواصفات القياسية الأوروبية (CE) والروسية (EAC) والأوكرانية . تعمل شركتنا بمبدأ التصنيع بأعلى مستويات الجودة والتسليم بالوقت المناسب المحدد ، وفي السياق ذاته نبيع منتجات العديد من الماركات المحلية والأجنبية . تلاحق شركتنا ركب التطور والتقدم في بلدنا وفي العالم بموظفيها الشباب وفنييها ومهندسيها ، وتهدف إلى التطوير المستمر والابتكار ، وتخطو خطوات واثقة نحو المستقبل على ضوء تجارب الماضي ، وتواصل تقديم خدماتها المتكاملة في هذا القطاع جنباً إلى جنب عملائها.

www.ahmetasansor.com.tr

AH & MET®

A nighttime cityscape featuring several illuminated skyscrapers. Two large, semi-transparent arrows, one light blue and one purple, point upwards from the bottom center towards the top right. The text "We are proud to satisfy more than 1000 customers." is overlaid in white in the upper right quadrant.

**We are proud to satisfy
more than 1000 customers.**



22 YEARS

AH & MET ELEVATOR
WIDE PRODUCT RANGE AND DOMESTIC-FOREIGN BRAND
IT IS A LIFT MARKET WHERE YOU CAN MEET
YOUR EVERY KIND OF NEEDS.

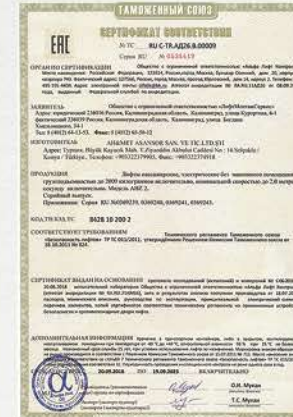
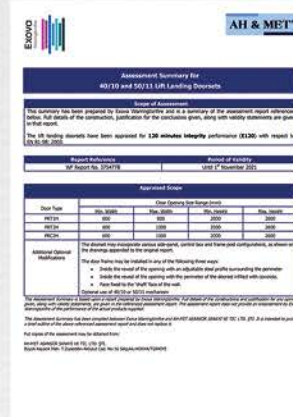

3
T
E
S
T
E
R
T
I
F
I
C
A
T
E
S

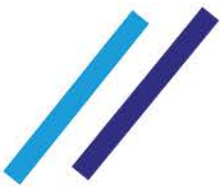

100 brands

With more than **100** brands
In **67** countries
In **179** cities

We are proud to satisfy
more than **1000** customers.

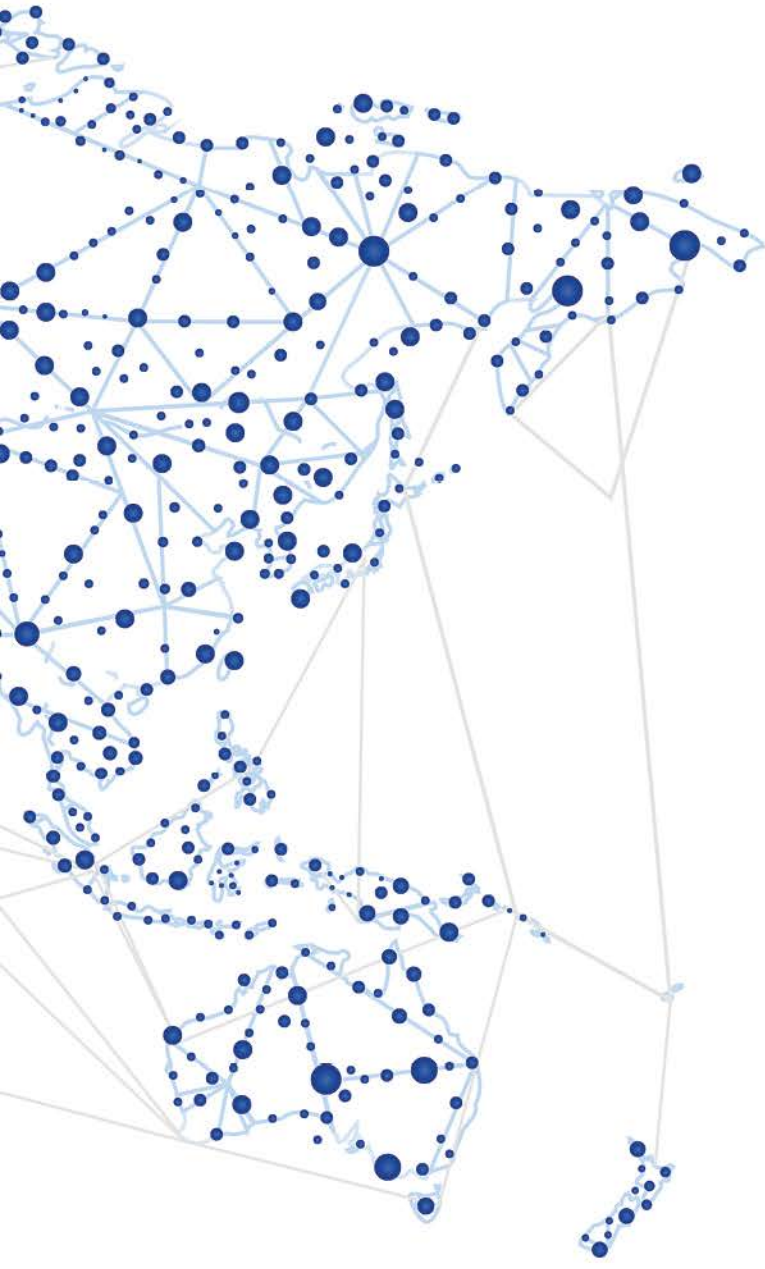

с более чем **100** брендов
В **67** странах, в **179** городах
Более **1000** довольных
клиентов - это наша гордость.

مع أكثر من **100** علامة تجارية
في **67** دولة في **179** مدينة
نحن فخورون بإرضاء أكثر من **1000** عميل.

We produce quality products
**with our wide product range
and experienced staff.**

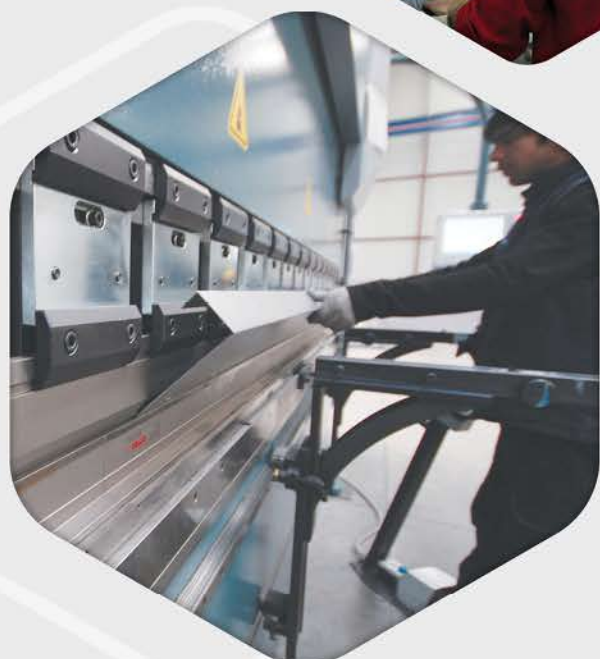

AH & MET[®]



We have combined
world-class
quality and technology.



**seasons change,
quality does not.**

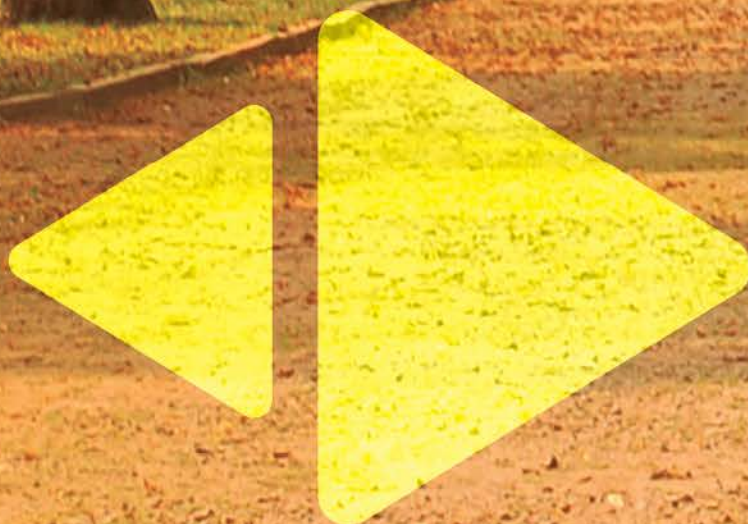



Tropik



AH & MET[®]

CABINS / КАБИНЫ / الكبائن

MANAS



DIZÖR



BAROK



AESTHETIC INTEGRITY
эстетическая целостность
النزاهة ، الجمالية



ALYANS



SUDE



SENTE



AH & MET[®]

CABINS / КАБИНЫ / الكبائن

AKAY



ZEN

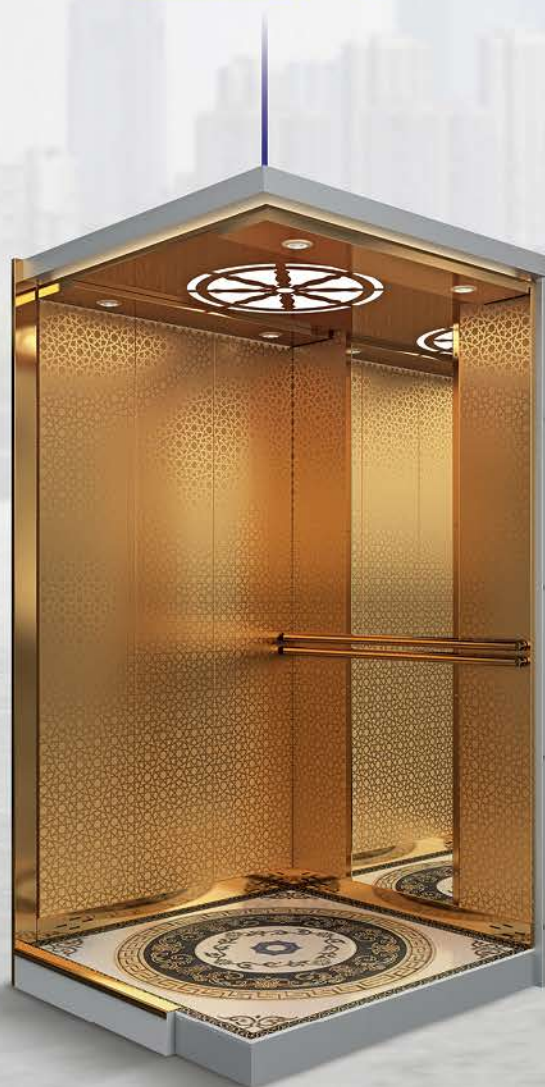

REAL



AESTHETIC INTEGRITY
Эстетическая целостность
النزاهة ، الجمالية



PANORAMİK



SAFİR



SEDYE



production



PH



roduction

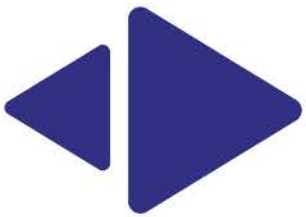
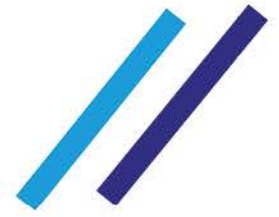

22.
years

OPEN THE DOOR OF THE
SUPERIOR TECHNOLOGY



AHZ Door®



AUTOMATIC DOORS
АВТОМАТИЧЕСКИЕ ДВЕРИ
أبواب أوتوماتيكية



AHZ Door



COMFORTABLE, SAFE, EFFICIENT

Комфортно, безопасно, продуктивно

مريح، آمن، فعال

AHZ Door



fermator
AUTOMATIC DOORS FOR LIFTS



WITTUR

AH & MET[®]

MANUAL DOORS
ДВЕРИ
أبواب نصف أوتوماتيكية



from past to present

technical drawing

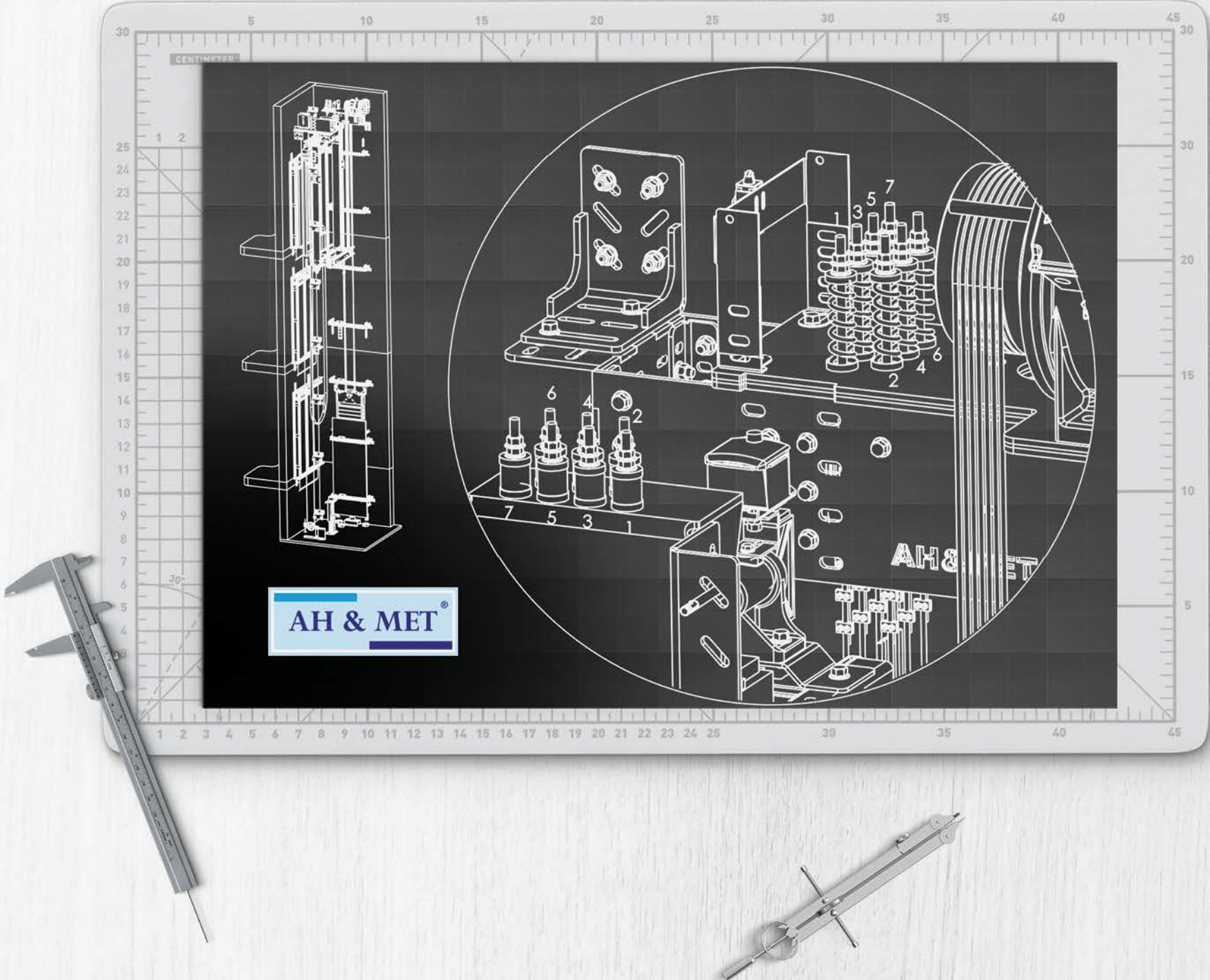

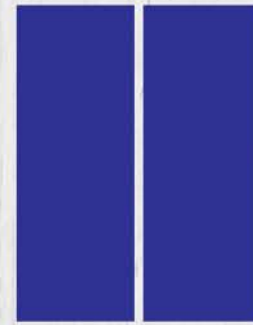
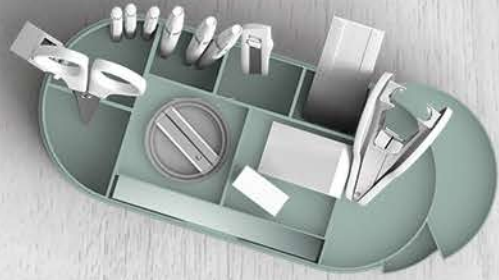

We have been
doing our job with
love since 1998

AH & MET[®]



AH & MET[®]

SYSTEMS / Системы / نظم



//
**WITH
MA
CHI
NE
ROOM**

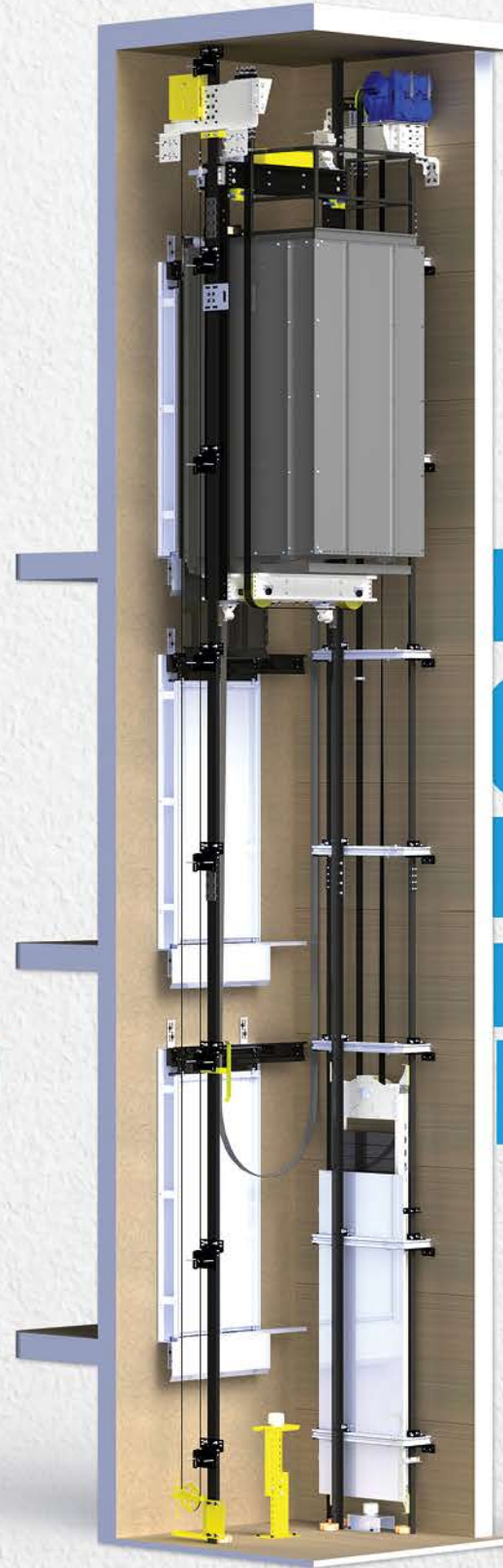

//
**MA
CHI
NE
ROOM
LESS**

TECHNICAL SYSTEMS FOR MODERN LIFE

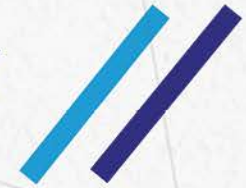

PASSENGER ELEVATOR (CLASS 1)

Capacity		300	375	450	600	750	1000
Person		4	5	6	8	10	13
Cabin Area	Min	0.79	0.98	1.17	1.45	1.73	2.15
	Max	0.95	1.17	1.30	1.66	2.00	2.40
System	1:1/2:1						
Maximum Travel Distance	105 m						
Stop	35						
Speed	0,63 m/s - 2,5 m/s						
The elevators designed to carry people							

PASSENGER AND FREIGHT ELEVATOR (CLASS 2)

Capacity		600	750	1000	1275	1600	2000
Number of People		8	10	13	17	21	27
Cabin Area	Min	1.45	1.73	2.15	2.57	3.25	3.82
	Max	1.66	2.00	2.40	2.90	3.56	4.20
System	1:1/2:1						
Maximum Travel Distance	105 m						
Stop	35						
Speed	0,63 m/s - 2,5 m/s						
The elevators mainly designed to carry people but can carry loads when necessary.							

HOSPITAL ELEVATOR (CLASS 3)

Capacity		1275	1600	2000	2500
Person		17	21	27	33
Cabin Area	Min	2.57	3.25	3.82	4.63
	Max	2.90	3.56	4,20	5
System	1:1 / 2:1 / 4:1				
Maximum Travel Distance	105 m				
Stop	35				
Speed	0,63 m/s - 2,5 m/s				
The elevators designed for health and maintenance purposes, including hospitals and nursing homes.					

FREIGHT ELEVATOR (CLASS 4)

Capacity		1000	1275	1600	2000	2500	3000	3500	4000	5000
Person		13	17	21	27	33	40	47	53	67
Cabin Area	Min	2.15	2.57	3.25	4,625					
	Max	2.40	2.90	3.56	5					
System	1:1 / 2:1 / 4:1									
Maximum Travel Distance	105 m									
Stop	35									
Speed	0,50 m/s - 2,0 m/s									
The elevators mainly designed to carry load under the human control.										

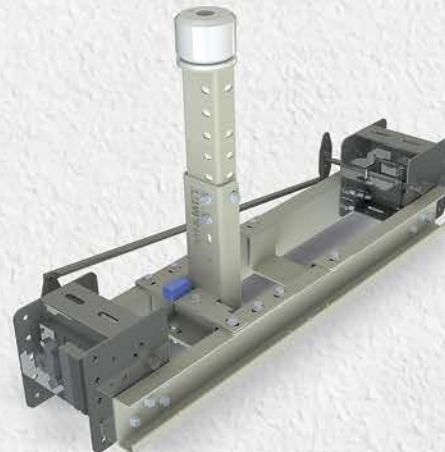
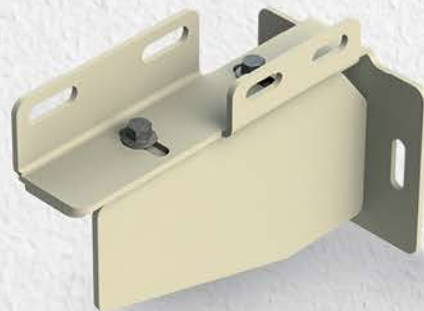
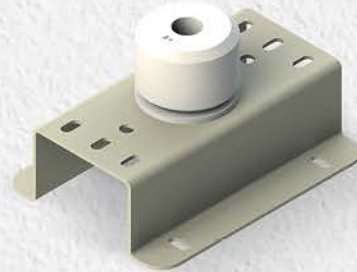

COMFORTABLE, SAFE, EFFICIENT

Комфортно, безопасно, продуктивно

مريح، آمن، فعال



АН & MET®

BUTTONS /
ПРИКАЗНЫЕ ПОСТЫ КАБИНЫ И ВЫЗВНЫЕ ПОСТЫ ЭТАЖА /

أزرار /



FULL CONTROL AT YOUR FINGERTIPS

CONTROL PANELS

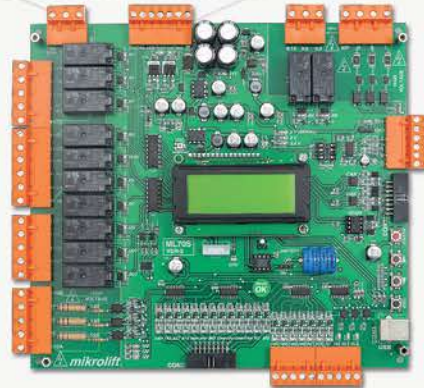

ML50S

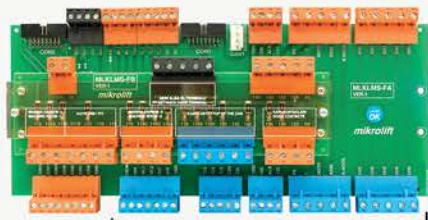

MLKLMS-FB

INSPECTION BOX

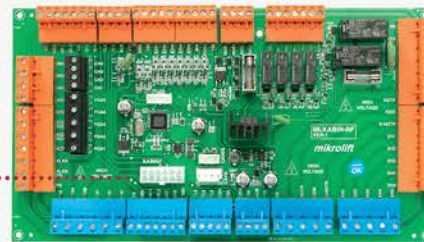

MLKABIN-RF

CABIN



MLKABIN-K



MLTFT



In serial wiring, high performance with affordable, connection without fault, save time and labor benefits from...

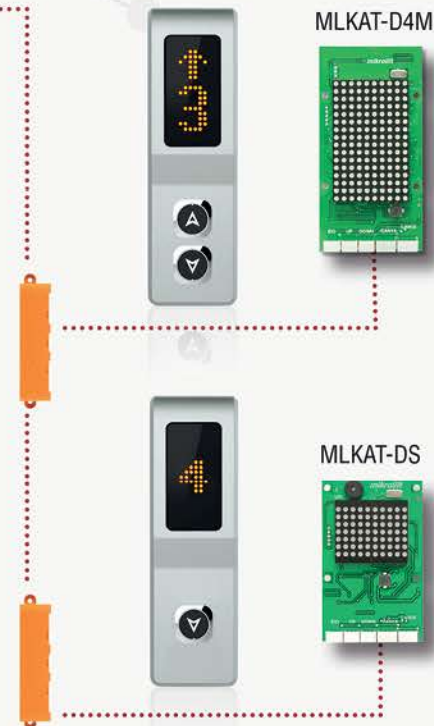

MLKAT-D4M

MLKAT-DS

LIFT CONTROLLER CARD

- Full serial communication
- Sensitive car level setting from the car buttons
- 32 floors
- Detailed fault tracking (hour,date)
- Double automatic door support
- Shaft learning

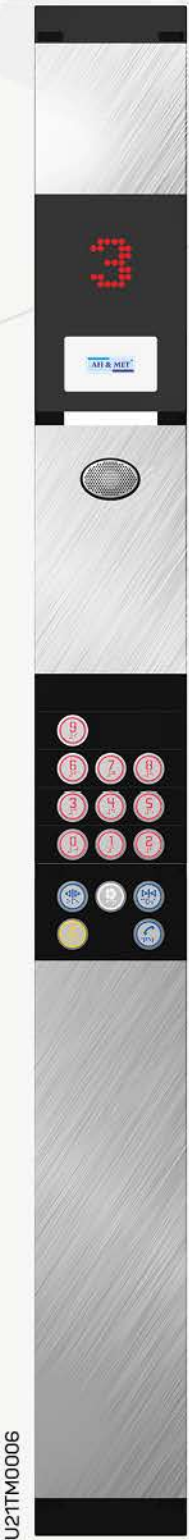

FULL CONTROL AT YOUR FINGERTIPS





BUTTONS /

ПРИКАЗНЫЕ ПОСТЫ КАБИНЫ И ВЫЗВНЫЕ ПОСТЫ ЭТАЖА /

آزار /



AC 732 CDD



AC 732 DSF



AC 933 CDD



AC 932 CT4D



MEGA 7V DM



RN1012



RN2012



UF-KSF



AV4070



AV1002



AV2002



AV3070



AV1072



AV2072



AV1082



AV2082

FULL CONTROL AT YOUR FINGERTIPS



AK-700-03



AK-600-01-90



AK-600-04



AK-500-01



AK-500-05



AK-300 K



AK-100 K



AK-110 K



AK-150 K



AK-160 K



AK-200 K



AK-215 K

AH & MET®

mikrolift



Fuji Electric
Innovating Energy Technology

ARKEL

LS

FEATURES

- High quality and safety
- Two Speed, VVVF speed control, Roomless, Hydraulic
- Mikrolift , Arkel quality of cards
- SCHNEIDER contactor system
- Adjustable up to 32 stops
- 60 errors memory with time and date
- Serial installation
- Alarm exit
- Adjustable park stop
- Serial Communication
- Electrostatic case
- Full automatic double door operation feature
- Earthquake and fire sensor input
- Residual voltage in security circuit
- Wide range of emergency rescue systems and UPS
- Transportation security with carton packing
- All panels include bi-stable and magnet
- Flexible cable connection point
- In-cabin lighting system in case of power cut
- Password protection program, PUK code against unauthorized use
- Voice warning system

ОСОБЕННОСТИ

- Высокое качество и безопасность
- Двухскоростной, VVVF-контроль скорости, Без машинного помещения, Гидравлический
- Широкий выбор аварийно-спасательных систем и UPS
- Выбор платы системы управления, различных фирм: MIKROLIFT, ARKEL
- Выбор системы контакторов SCHNEIDER
- Регулируется до 32 остановок
- Память на 60 ошибок с датой и временем
- Аварийный выход
- Серийная установка
- Последовательная связь
- Система звукового сигнала предупреждения
- -Полная автоматизация двойных дверей
- -Выход для датчика сенсора при землетрясениях и пожаре
- -Бесперебойное напряжение в схеме защиты
- -Регулируемая остановка кабины
- Электростатическая коробка
- Прочная упаковка для безопасной транспортировки
- Все панели оснащены датчиком точной остановки лифта
- Точка подключения подвесного кабеля
- Аварийная система освещения кабин в случае перебоя электропитания
- Программа системы управления защищена паролем, а так же PUK-код против несанкционированного использования

المواصفات

- إمكانية ضبط توقف المصعد (تجريش) .
- الصندوق مطلي بطلاء استاتيكي .
- تأمين توصيل المعدات أثناء النقل بالتعليق الكرتوني .
- المغناطيس stable-bi موجود في كل لوحاتنا .
- نقطة ربط الكابلات المرنة
- نظام إضاءة داخل الكابينة عند انقطاع التيار الكهربائي .
- خروج الإنذار
- نظام التحذير الصوتي .
- إمكانية قفل البرنامج بكود PUK لمنع الاستخدام الغير مرغوب
- التركيب التسلسلي .
- الاتصال التسلسلي .
- ميزات تشغيل المصعد ثنائي الباب الأتوماتيكي .
- مدخل لحساس الحريق والهزات الأرضية (سينسور) .
- تتبع تسريب التيار في دورة الحماية .
- جودة مرتفعة وحماية عالية .
- بدون غرفة ماكينة , سرعتين , سرعة VVVF , هيدروليكي .
- خيار جهاز الإنقاذ و UPS .
- خيارات الكرت الأم MIKROLIFT , ARKEL
- خيارات نظام القواطع (كونتكتور) SCHNIDER .
- إمكانية الضبط حتى 32 موقف .
- ذاكرة لتسجيل الأخطاء بسعة استيعابية تصل حتى 60 خطأ بالوقت و التاريخ .

CONTROL PANELS СТАНЦИИ УПРАВЛЕНИЯ

لوحات التحكم



AN & MET[®]

MACHINERY & MOTORS / ЛЕБЁДКИ / الآلات والمحركات



AKIS

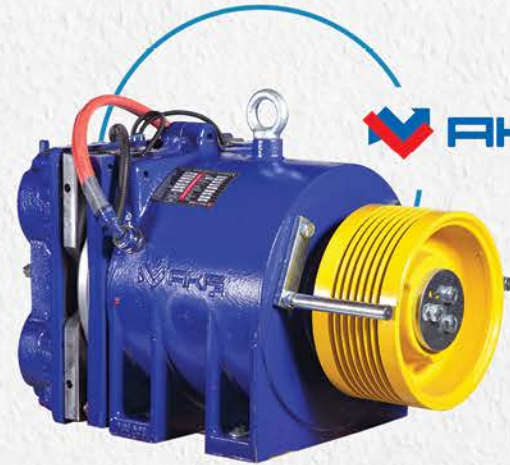

AKIS



eker

LAFERTMOTORS

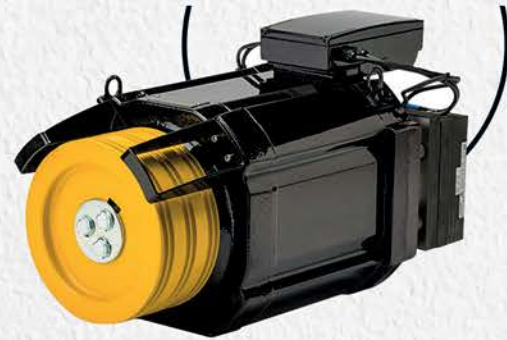

ALBERTO SASSI ASTOR
HIGHER LIFT TECHNOLOGY



ALBERTO SASSI ASTOR
HIGHER LIFT TECHNOLOGY

PROFESSIONAL SOLUTIONS

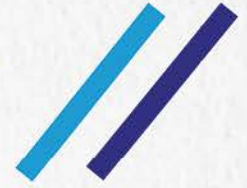

AH & MET[®]



OTHER PRODUCTS / ДРУГИЕ ПРОДУКЦИИ / المنتجات الأخرى

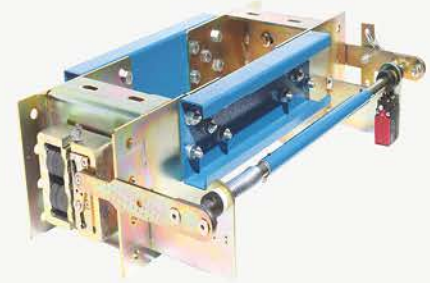
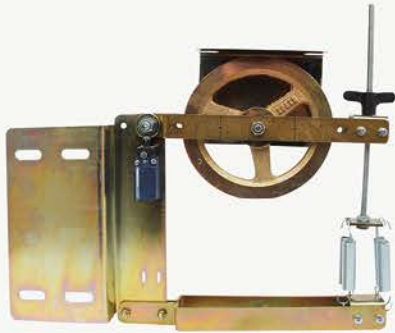
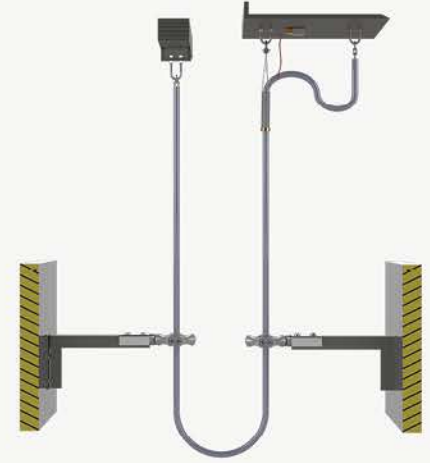
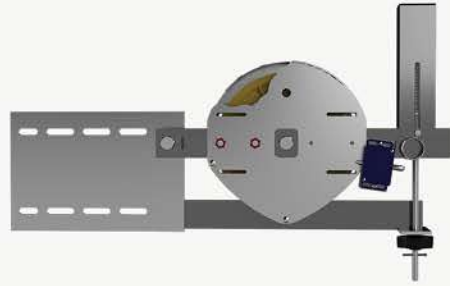

22
years

AH&MET ASANSÖR SANAYİ VE TİC. LTD. ŞTİ

3. Organize San. Bölgesi T. Ziyaeddin
Akbulut Cad. No:16 Konya / TURKEY

+90 332 237 99 05 • +90 332 237 49 18

bilgi@ahmetasansor.com.tr

www.ahmetasansor.com.tr

